

STRONGER. SHARPER.  
2015

**United**<sup>®</sup>  
**CUTLERY**  
[WWW.UNITEDCUTLERY.COM](http://WWW.UNITEDCUTLERY.COM)

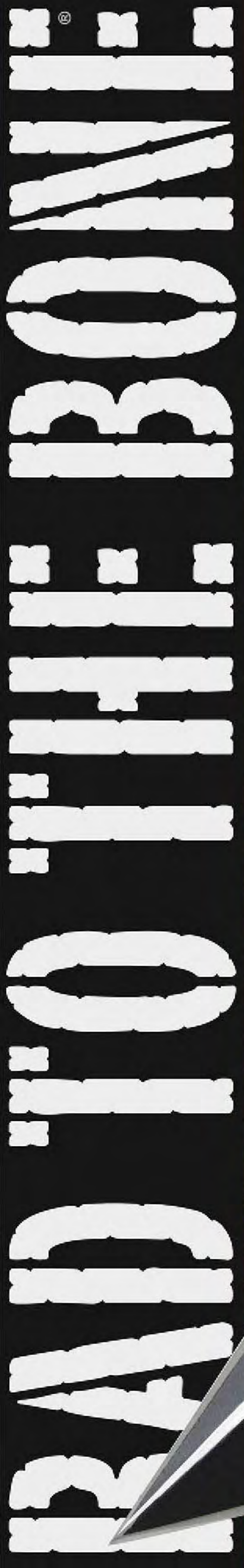
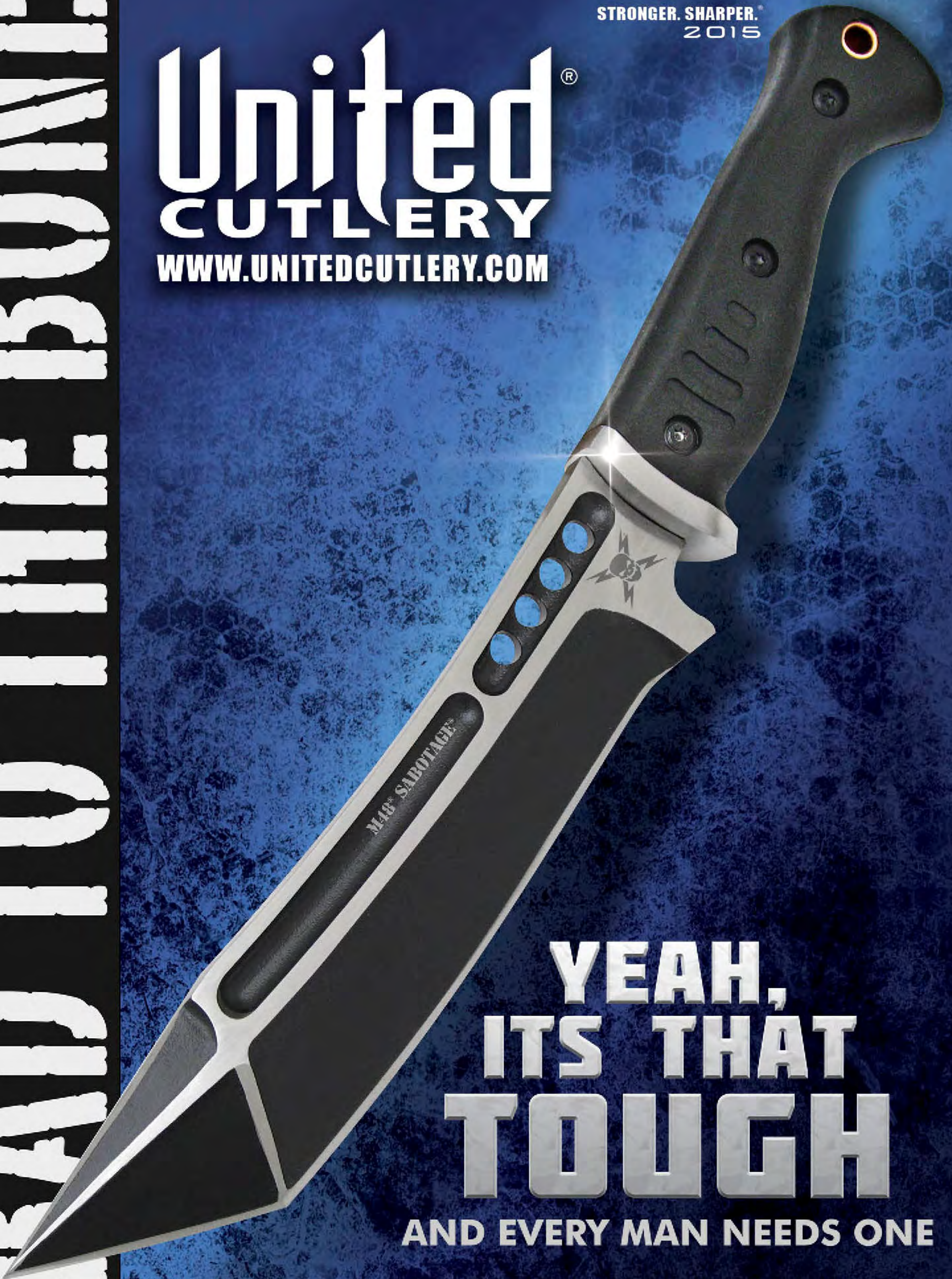

**YEAH,  
ITS THAT  
TOUGH**

**AND EVERY MAN NEEDS ONE**



# United<sup>®</sup>

CUTLERY

THE ONLY SOURCE FOR  
**STRONGER. SHARPER<sup>®</sup>**  
BRANDS THAT CRUSH  
THE COMPETITION!



**DON'T BE FOOLED  
BY CHEAP IMITATIONS!**

**NEW!**



You  
Tube



**PRODUCT VIDEOS  
NOW AVAILABLE!**  
[youtube.com/unitedcutlery](http://youtube.com/unitedcutlery)

## ORDERING INFORMATION

CALL A REPRESENTATIVE TODAY!  
**1-800-548-0835** or **229-890-6669**  
or by fax **1-229-985-4861**

**United<sup>®</sup> Cutlery Corporation**  
**475 US Highway 319 South**  
**Moultrie, GA 31768**

### WARNING!

**These adult collectibles are not intended  
for persons under 18 years of age.**

Release, Assumption of Risk, and Waiver of Liability and Indemnity Agreement: By purchasing any item from United<sup>®</sup> Cutlery, the buyer warrants that he is in compliance with all federal, local, and state laws and is legally able to purchase and sell any and all items illustrated.

*All prices and specifications are subject to change without notice. Country of origin subject to change.*

# THE WORLD LEADER IN LICENSED COLLECTIBLES

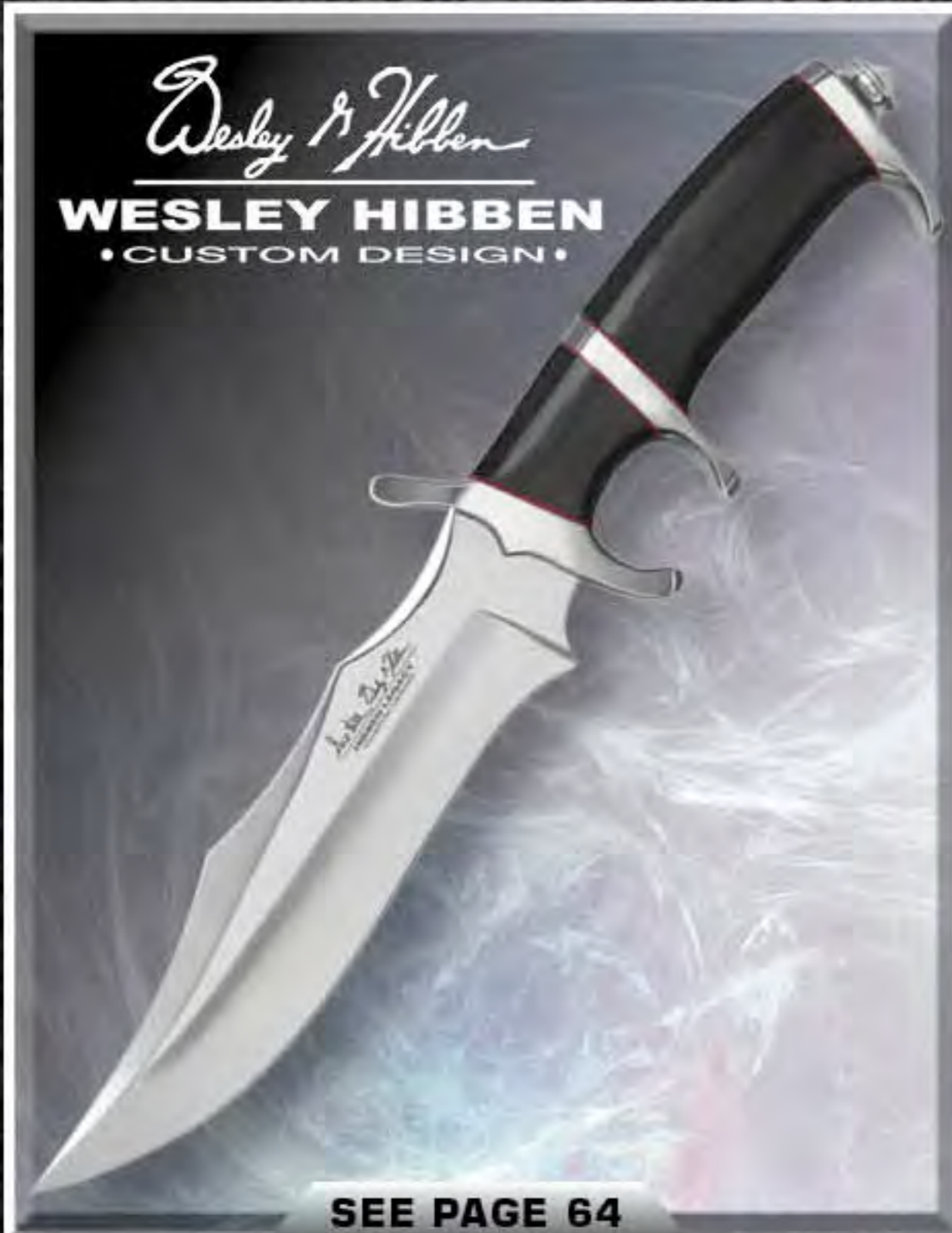

SEE PAGE 64



SEE PAGE 54

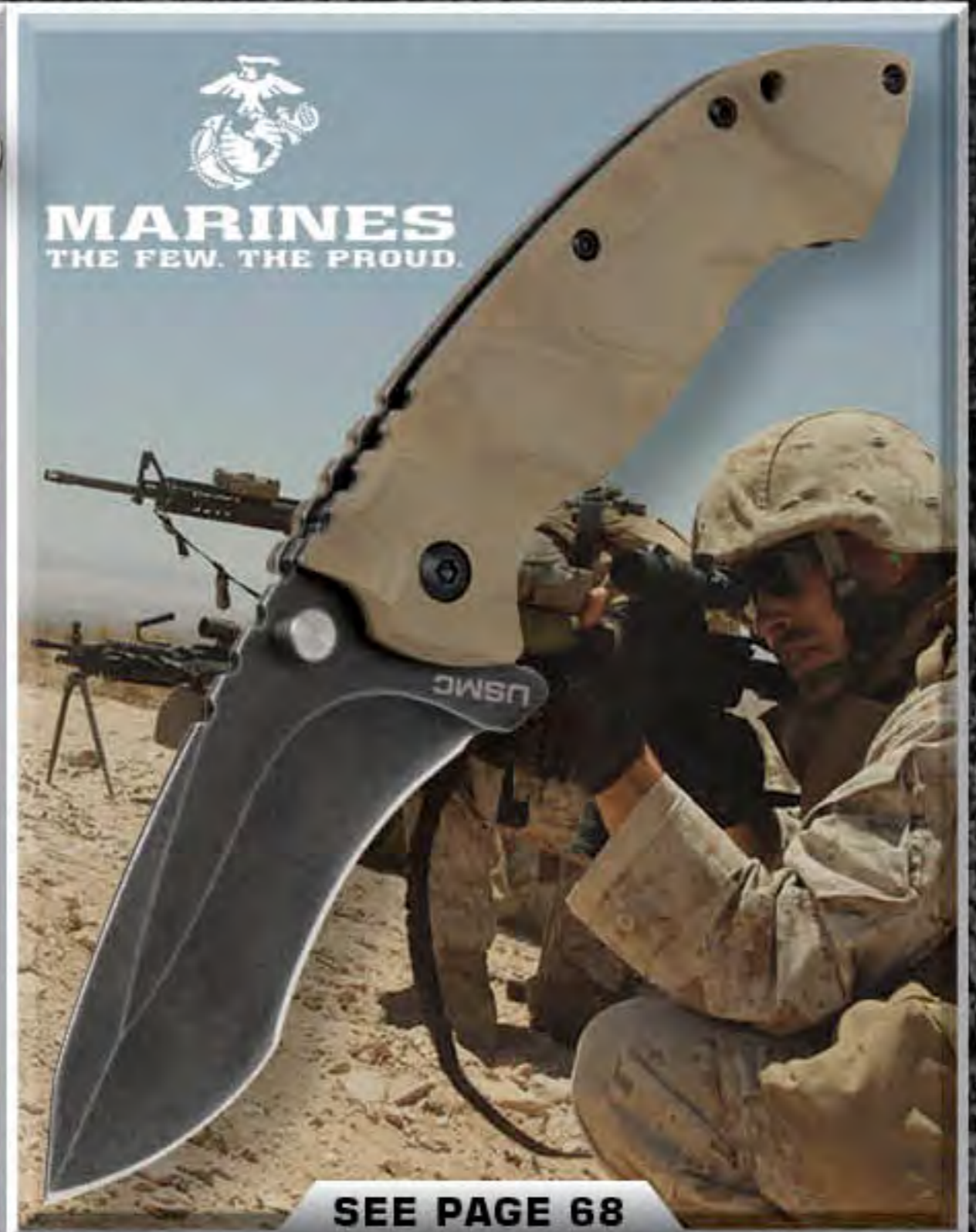

SEE PAGE 68



SEE PAGE 65

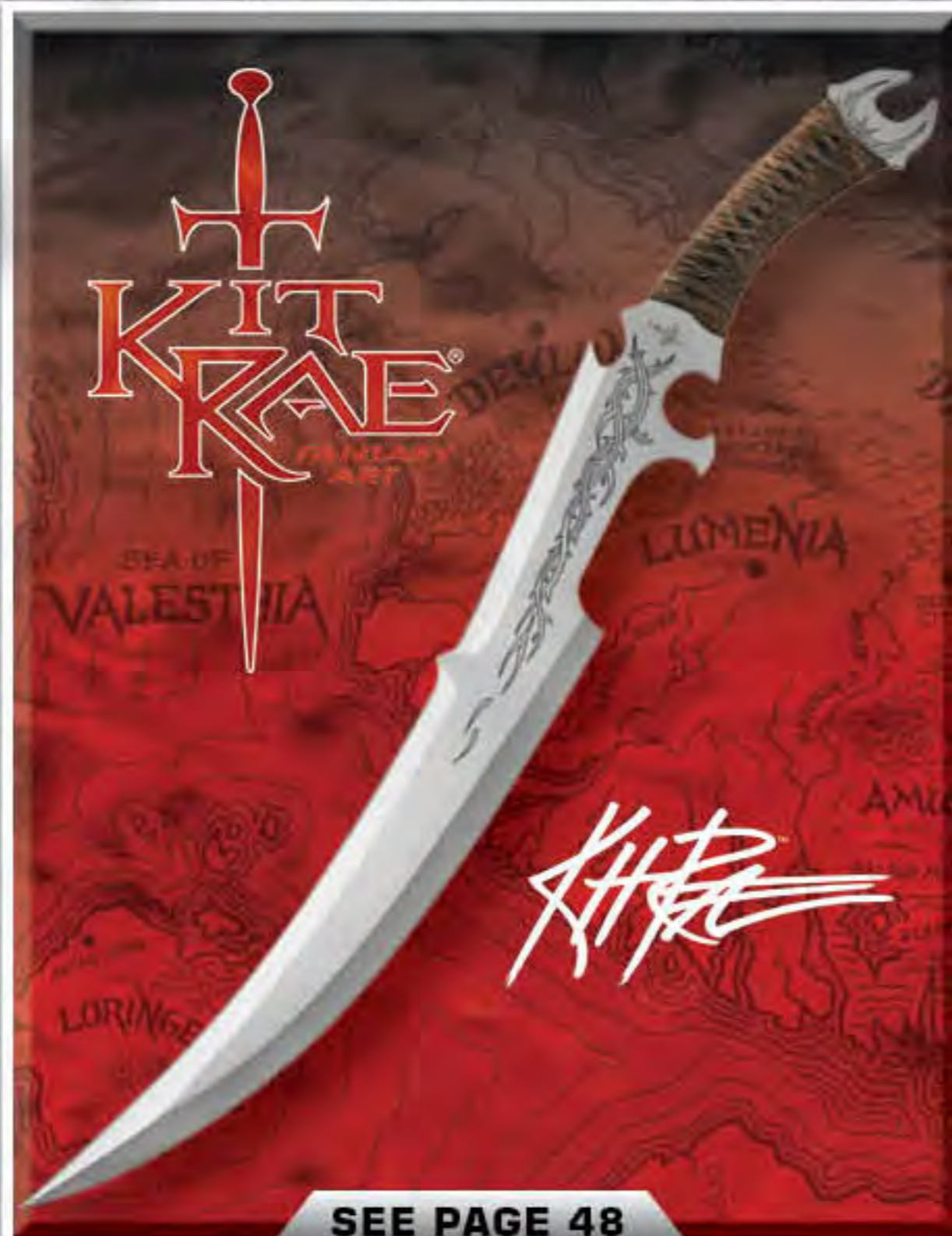

SEE PAGE 48



SEE PAGE 44



SEE PAGE 34



When you are trying to survive, no other brand has your back like United® Cutlery's M48® lineup!

M48® items are crafted with top-grade materials and custom designs that are meant to make you a commando in your own right. No job is too tough for these powerful blades and tools.

**YEAH,  
ITS THAT  
TOUGH**

AND EVERY MAN NEEDS ONE

## M48® Tactical War Hammer

- Heads/blades secured by three separate bolts
- 7 3/4" cast 2Cr13 stainless steel head
- Powerful curved back spike
- 30% fiberglass & reinforced nylon handle
- Measures 15 1/2" overall in length
- Includes TPR head cover and a nylon sheath with a Velcro closure

### A. M48® Tactical War Hammer

7 3/4" head, 15 1/2" overall

#UC3069

List \$92<sup>00</sup>



ALL BLADES ARE SECURELY ATTACHED TO THE HANDLE WITH THREE SEPARATE BOLTS.



Includes M48® flexible TPR sheath and nylon belt frog for easy carry



## M48<sup>®</sup> Tactical Double Bladed Axe

You've been asking for it, and United<sup>®</sup> Cutlery has delivered in a big way with this all new double-bladed tactical tomahawk from the best-selling M48<sup>®</sup> lineup. This bad boy does double duty with two 5-1/2" sharpened blades.

- Double-blade tomahawk design
- 2Cr13 stainless steel construction
- Nylon and fiber-reinforced handle
- Black oxide blade finish
- Nylon blade sheath

A. M48<sup>®</sup> Tactical Double Bladed Axe  
5 1/2" blade,  
16 7/8" overall  
#UC3056  
List \$93<sup>00</sup>

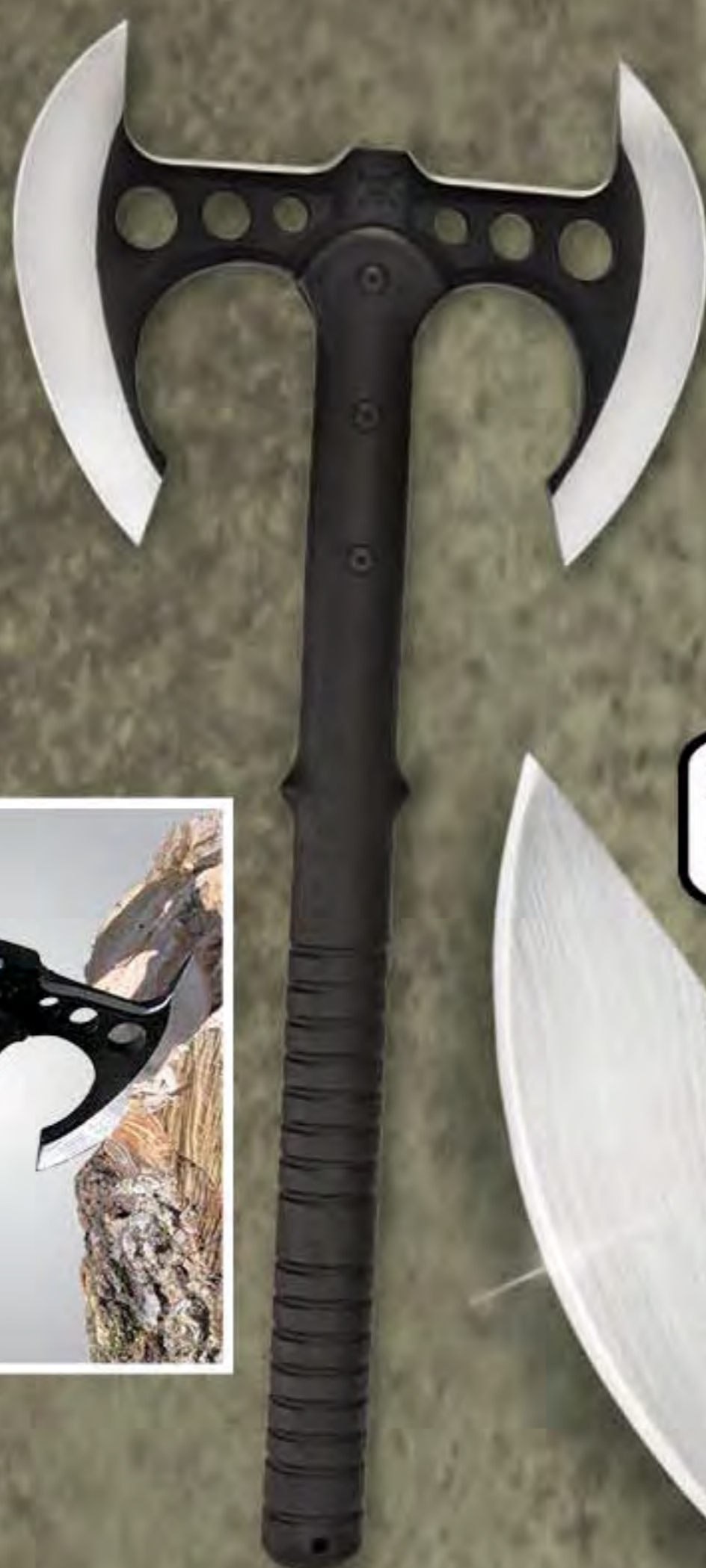
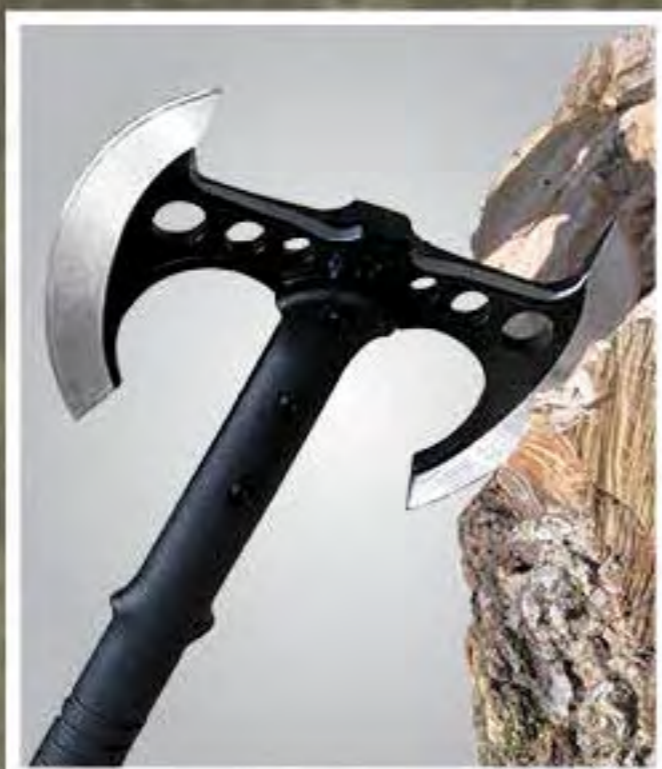

**MOLLE**  
ADAPTABLE  
SHEATH

**NEW!**



**NEW!**

**WICKED SHARP**

## M48<sup>®</sup> Tactical Kama

- Cast 2Cr13 stainless steel head
- Razor-sharp edge & piercing point
- Nylon & fiberglass reinforced handle
- Reinforced nylon M48 blade sheath

B. M48<sup>®</sup> Tactical Kama  
8 1/4" head, 15 1/2" overall  
#UC3017  
List \$80<sup>00</sup>





## New M48® Magnum Karambit

A magnum-sized modern update to the traditional karambit design. Features large finger grooves and ring for a secure grip that makes it difficult to be disarmed. Incorporates defensive punching/hammer points on the finger ring.

- One-piece, full-tang tempered 2Cr13 stainless steel construction
- Black oxide hard coated
- Flexible TPR sheath

**A. Magnum Karambit**  
 3 1/8" blade, 9" overall  
 #UC3102  
 List \$46<sup>00</sup>



**NEW!**

# YEAH, ITS THAT TOUGH

AND EVERY MAN NEEDS ONE

**WICKED SHARP**

M48®  
KARAMBIT



## M48 Hawk® Harpoon With Sheath

This M48 Hawk® Harpoon knife features a razor-sharp blade that will slice through anything like butter and a tip that will penetrate practically any target effortlessly. The wicked curve of this powerful blade allows it to be used for a variety of purposes.

- Can be used for hunting, fishing, and much more
- Solid piece of rock-hard AUS-6 stainless steel
- Rubberized sheath houses knife securely
- Lashing holes • Black oxide coating

**B. M48 Hawk® Harpoon**  
 8 1/4" overall  
 #UC2971  
 List \$45<sup>00</sup>

**SURVIVAL  
APPROVED**



Lashing holes allow you to attach this harpoon knife to a wooden rod or stick, making an excellent harpoon or spear that can be used for hunting, fishing, and much more.

## New M48<sup>®</sup> Naginata Polearm

A massive polearm with a modern take on the traditional naginata blade

- 30% fiberglass reinforced nylon handle with a secure grip for thrusting or slashing
- Tempered 2Cr13 stainless steel blade, black oxide hard coated
- Flexible TPR blade cover

### A. Naginata Polearm

10" blade, 57 1/2" overall

#UC3101

List \$165<sup>00</sup>

**SOLID HALF-INCH-THICK STEEL!**



**NEW!**



**WICKED SHARP**

## New M48<sup>®</sup> Urban Stinger<sup>®</sup> With Shoulder Harness

This top-quality spike that won't bend or break like cheap imitations. The rubberized, textured handle provides a sure grip so you can wield this spike confidently, and the rubberized shoulder sheath will house it securely.

- Rock-solid 2Cr13 stainless steel
- Anodized, non-reflective black coating
- Razor-sharp edge & piercing point
- Rubberized, textured handle grip each
- Includes shoulder harness
- 3-3/4" blade
- 8" overall

**NEW!**



**NEW!**

**SECURE FIT  
HAND GRIP**

### B. M48<sup>®</sup> Urban Stinger<sup>®</sup>

8" overall

#UC2936

### C. M48<sup>®</sup> Urban Stinger<sup>®</sup> Black

#UC2937

List \$57<sup>00</sup> each





Devastating when thrown, it pierces through a car hood and chops wood with ease.



## M48® Tactical Tomahawks

- Rugged 30% fiberglass reinforced handle is nearly indestructible
- Axe blade is excellent for chopping & breaching
- Well balanced for precise throwing
- Includes snap closure nylon belt sheath
- 8" head 3 7/8" blade • 2Cr13 stainless steel
- Double-edged spike tip
- 15" overall

**MOLLE**  
ADAPTABLE  
SHEATH



**B**

B. Our nylon ranger sheath is designed with a pocket for the compass and a tactical cord wrapped handle with carabiner.



**A. M48® Hawk Tactical Tomahawk**  
8" head, 15" overall  
#UC2765  
List \$63<sup>00</sup>

**B. M48® Ranger Hawk Axe with Compass**  
8" head, 15" overall  
#UC2836  
List \$85<sup>00</sup>

## M48® Compact Tactical Tomahawk

- Rugged 30% fiberglass reinforced handle is nearly indestructible
- Axe blade is excellent for chopping & breaching
- Well balanced for precise throwing
- Includes snap closure nylon belt sheath
- 8" head 3 7/8" blade
- 2Cr13 stainless steel
- Double-edged spike tip

**NEW!**



**C. M48® Compact Camp Hawk**  
5 1/2" head, 3" blade  
9 1/4" overall  
#UC3118  
List \$49<sup>50</sup>

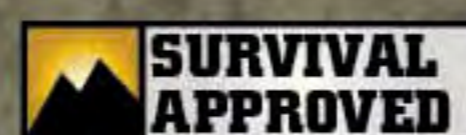

## M48® Tactical Survival Axe

- 37" overall length allows for extended reach and doubles as a walking aid • 2Cr13 steel
- Axe blade is excellent for chopping
- Includes flexible TPR blade sheath

TPR sheath snaps securely in place.



**D. M48® Tactical Walking Axe**  
4 1/2" blade, 37" overall  
#UC2905  
List \$130<sup>00</sup>

## M48® Survival Hammer

- Effective breaching tool or defensive hammer
- 2Cr13 steel defensive war hammer head
- Curved back spike handle

**E. M48® Survival Hammer**  
37" overall  
#UC2960  
List \$161<sup>00</sup>

Devastating head design and slim profile shown



The survival axe is a great tool for rangers and border patrol agents. It can be used as a hiking staff and also as an axe or breaching tool. The rugged 30% fiberglass handle can also be used as a shield against knife attacks.





## M48 Talon® Survival Spear

- Razor-sharp 2Cr13 steel spear blade is nearly 1/2" thick
- Devastates practically any target effortlessly
- Includes flexible TPR blade sheath

### A. M48 Talon® Survival Spear

8" blade, 44 1/8" overall

#UC2961

List \$130<sup>00</sup>

**WICKED SHARP**



Sharp enough  
and strong enough!

**SOLID HALF-INCH-THICK STEEL!**

A



**SECURE FIT  
HAND GRIP**

B



## The M48® Tactical Shovel

- Sharp concave chopping edge and partially serrated edge
- Includes a reinforced nylon belt pouch
- Doubles as a defensive weapon
- Shovel point edge is sharpened
- The ultimate tactical shovel
- Cast 2Cr13 stainless steel

### B. M48® Tactical Shovel

16 1/4" overall

#UC2979

List \$77<sup>00</sup>

Includes M48®  
reinforced nylon  
belt sheath



Ergonomic, tactical  
design and slim profile  
shown for perspective.



Sharp enough,  
and strong enough!

# M48® Sabotage® Tanto Fighter

- Razor-sharp blade with modified tanto point
- Cast 2Cr13 stainless steel construction
- Bead-blasted black oxide blade finish
- Injection-molded TPR handle
- Includes nylon belt sheath with rubberized blade cover

A. M48® Sabotage® Tanto Fighter  
 7 15/16" blade, 13 1/16" overall  
 #UC3016  
 List \$90<sup>00</sup>



Rubberized blade sheath included

A

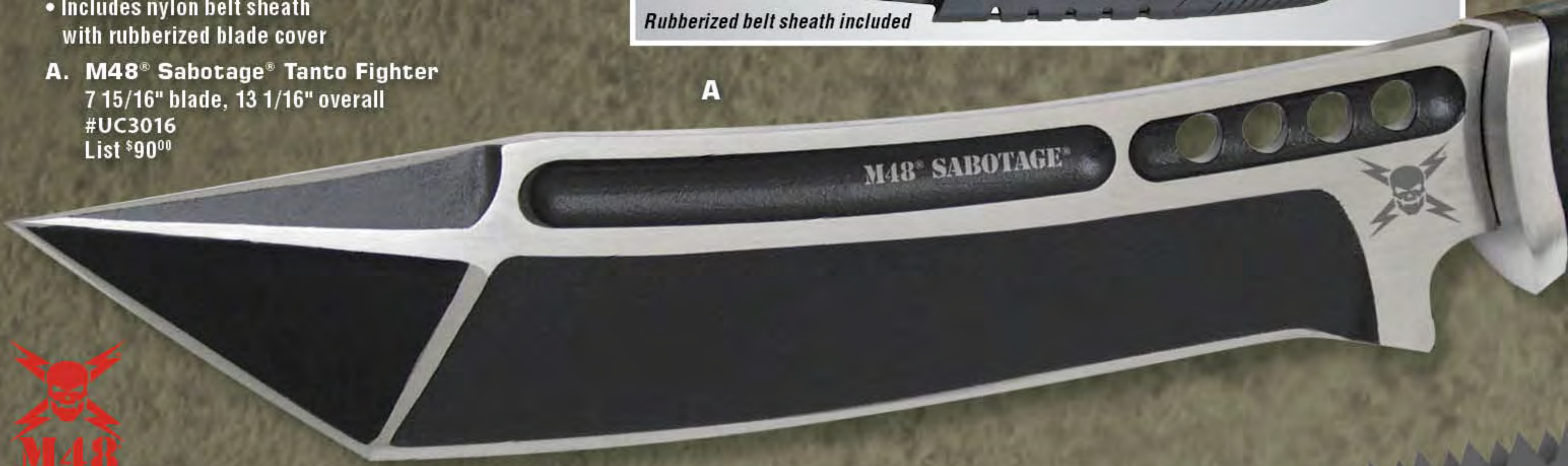

- Large front pocket with hook and loop closure
- Several lashing attachment points
- M.O.L.L.E. compatible webbing
- A.B.S. reinforced tactical nylon
- Knife retention strap with snap
- Extra secure belt loops
- Leg retention cord

**MOLLE**  
 ADAPTABLE  
 SHEATH

Items B, C, D include heavy-duty nylon sheath.

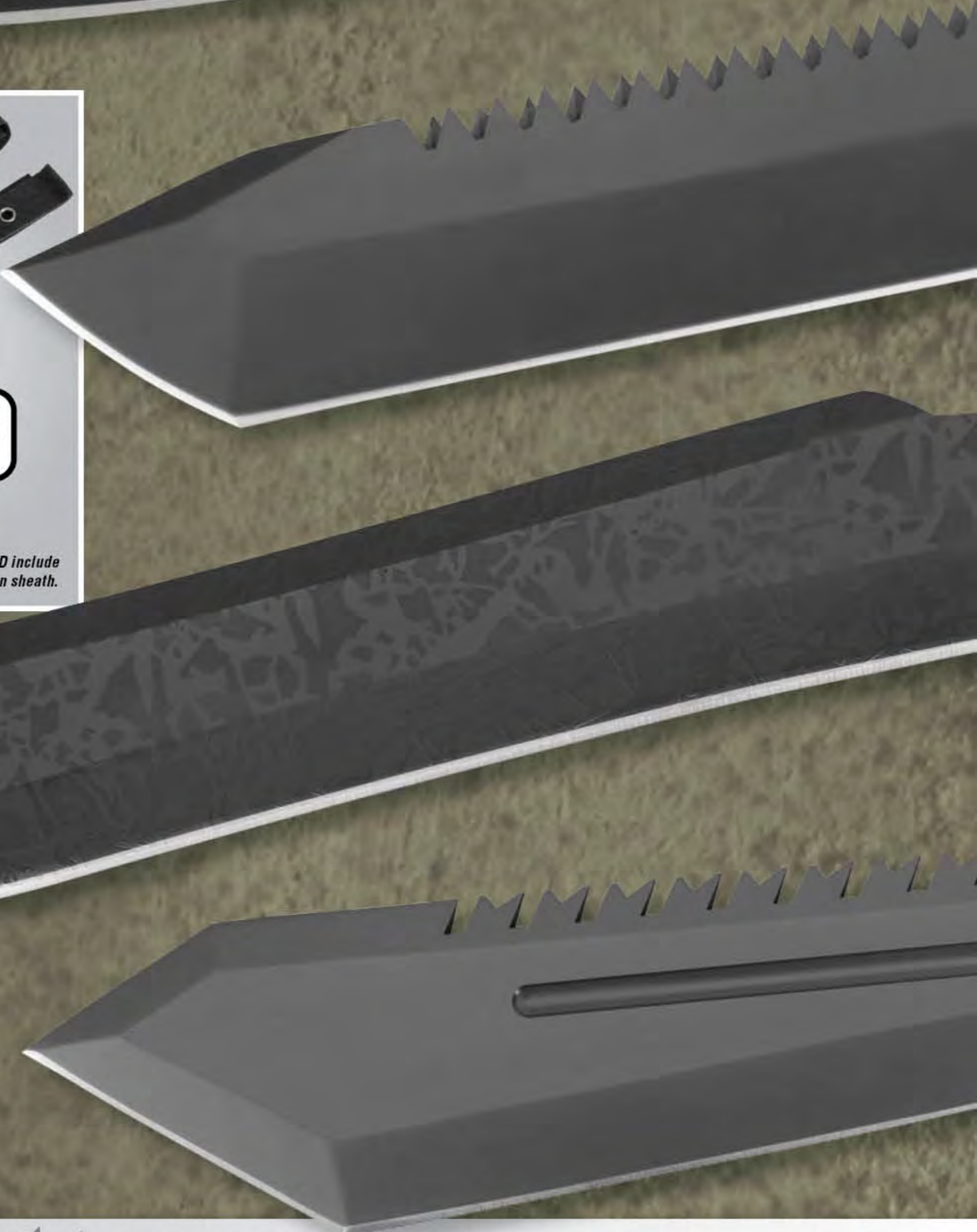

## M48 OPS® Tactical Blades

- Full-tang 420A stainless steel construction
- Reinforced, impact-resistant handle
- Razor-sharp blades with piercing points
  - Titanium electroplated finish
- Heavy sawback serrations (B,D)
- M.O.L.L.E. adaptable sheaths



**YEAH,  
IT'S THAT  
TOUGH**

AND EVERY MAN NEEDS ONE

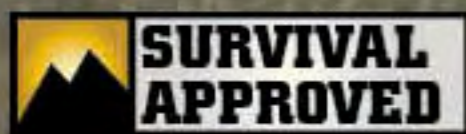
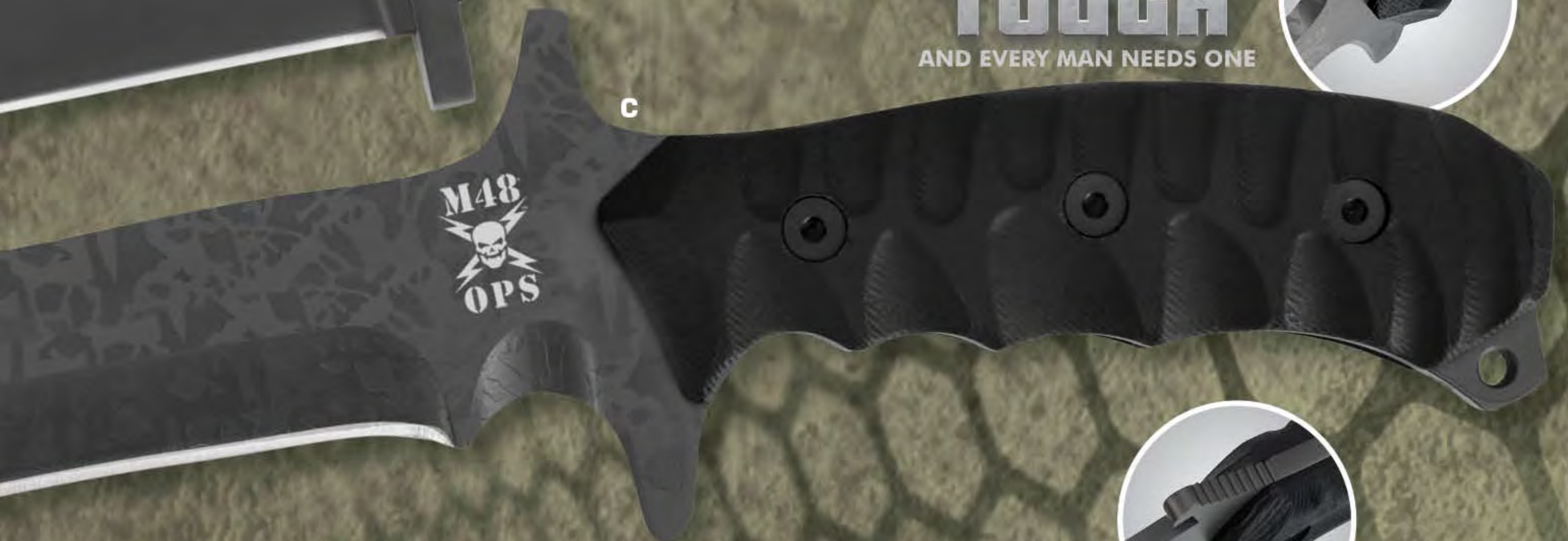

*New & Improved Serrations  
For Serious Cutting Power!*

**B. M48 Ops®  
Combat Fighter**  
16" overall  
#UC3021  
List \$170<sup>00</sup>

**C. M48 Ops®  
Combat Machete**  
17 3/4" overall  
#UC3023  
List \$165<sup>00</sup>

**D. M48 Ops®  
Combat Bowie**  
16" overall  
#UC3024  
List \$147<sup>00</sup>



# COMBAT COMMANDER

All Combat Commander boot knives are battle tested and ready for action! For fast, reliable protection whenever you need it, these United Cutlery boot knives offer excellent concealment and strength in one small package. The razor-sharp, double-edged blades will pierce through practically any target with ease. Whether you choose the shoulder harness or the boot sheath, you'll be prepared for almost anything with any of these menacing blades.

## Original Combat Commander Boot Knives

- Fiberglass-filled, injection-molded handles with lanyard holes
- Concealment & superior strength in each small package
- Excellent grip • AUS-8 blades
- Multiple carry options
- Fast, reliable protection



B, C

A

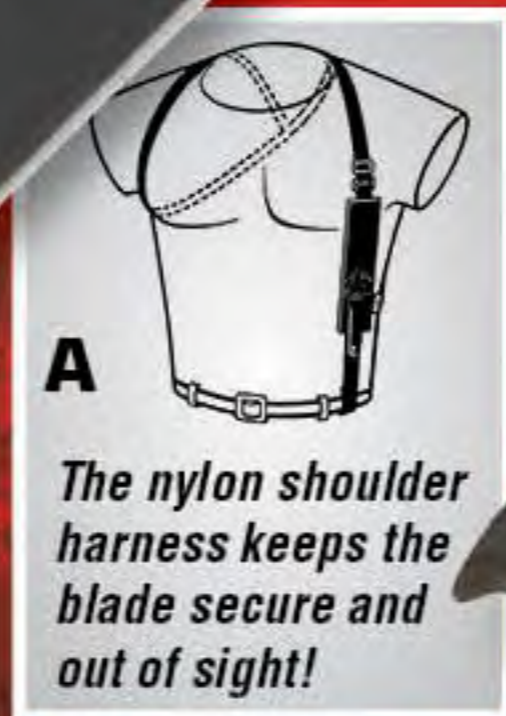

A  
The nylon shoulder harness keeps the blade secure and out of sight!



Cuts through tires like butter!

**A. Combat Commander Boot Knife Black with Shoulder Harness**  
5 1/4" bl., 9 1/2" ov.  
#UC2657  
List \$31<sup>00</sup>

**B. Combat Commander Boot Knife with Boot Sheath**  
5 1/4" bl., 9 1/2" ov.  
#UC2658  
List \$31<sup>00</sup>

**C. Combat Commander Black Boot Knife with Boot Sheath**  
5 1/4" bl., 9 1/2" ov.  
#UC2698 (NOT SHOWN)  
List \$32<sup>00</sup>

**D. Combat Sub Commander Mini Boot Knife**  
2 5/8" bl., 5 1/8" ov.  
#UC2725  
List \$20<sup>00</sup>

**E. Combat Sub Commander Black Mini Boot Knife**  
2 5/8" bl., 5 1/8" ov.  
#UC2724  
List \$20<sup>00</sup>

D, E - Mini boot knives face up for easy concealment on boots or packs

D

E



B, C

Heavy-duty leather boot clip sheath stays put!

**WICKED SHARP**



INSPIRED BY HISTORY



A

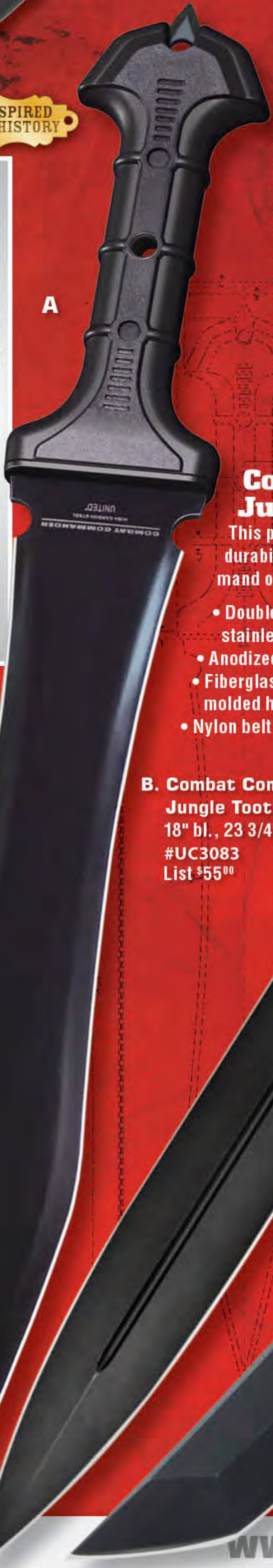

### Combat Commander Gladiator Sword

Defend yourself like the toughest of warriors with United® Cutlery's new Combat Commander Gladiator Sword. The Combat Commander Gladiator Sword features a powerful piece of thick, razor-sharp 1060 carbon steel built to defend. The TPR rubberized handle provides a sure grip as you wield this mighty sword. Carry it in the reinforced nylon sheath.

- Razor-sharp black-coated 1060 carbon steel blade
- Powerful full-tang blade construction
- Slip-resistant TPR rubberized handle
- Piercing point for deep penetration
- Reinforced nylon belt sheath

**A. Combat Commander Gladiator Sword with Sheath**  
 16 5/8" bl., 24" ov.  
 #UC3009  
 List \$47<sup>00</sup>

**NEW!**

### Combat Commander Jungle Toothpick

This powerful full-tang blade provides durability and strength to take command of even your toughest jobs.

- Double-edged AUS-6 stainless steel blade
- Anodized black finish
- Fiberglass/nylon injection molded handle
- Nylon belt sheath

**B. Combat Commander Jungle Toothpick**  
 18" bl., 23 3/4" ov.  
 #UC3083  
 List \$55<sup>00</sup>



Shown in sheath



B

Take action with the Toothpick



**NEW!**

# YEAH, ITS THAT TOUGH

AND EVERY MAN NEEDS ONE

### Combat Commander Tanto

United® Cutlery has updated the popular Combat Commander series with an all new Combat Commander Tanto. The shoulder harness sheath allows you to carry this bad boy discreetly so you're ready to defend yourself at a moment's notice.

- Razor-sharp stainless steel tanto blade
- Non-reflective black anodized coating
- Injection-molded, slip-free handle
- Lanyard hole & shoulder harness



**C. Combat Commander Tanto**  
 6 1/4" bl., 10 11/16" ov.  
 #UC3028  
 List \$32<sup>00</sup>



## Bushmaster® Survival Knife

The Bushmaster® survival knife features heavy sawback serrations and a cast metal handle with a built-in compass, providing you with a durable survival knife you can count on.

### A. Bushmaster® Survival Knife

10" blade, 15 1/4" overall

#UC0212

List \$75<sup>00</sup>



# BUSHMASTER®

ULTIMATE SURVIVAL



A. Kit includes: sewing needles, fish hooks, band aids, fishing line & sinkers, hooks, matches, alcohol swabs, fire starter with compass, survival whistle, snake bite kit, and several feet of survival paracord.



**SEARCH & RESCUE**

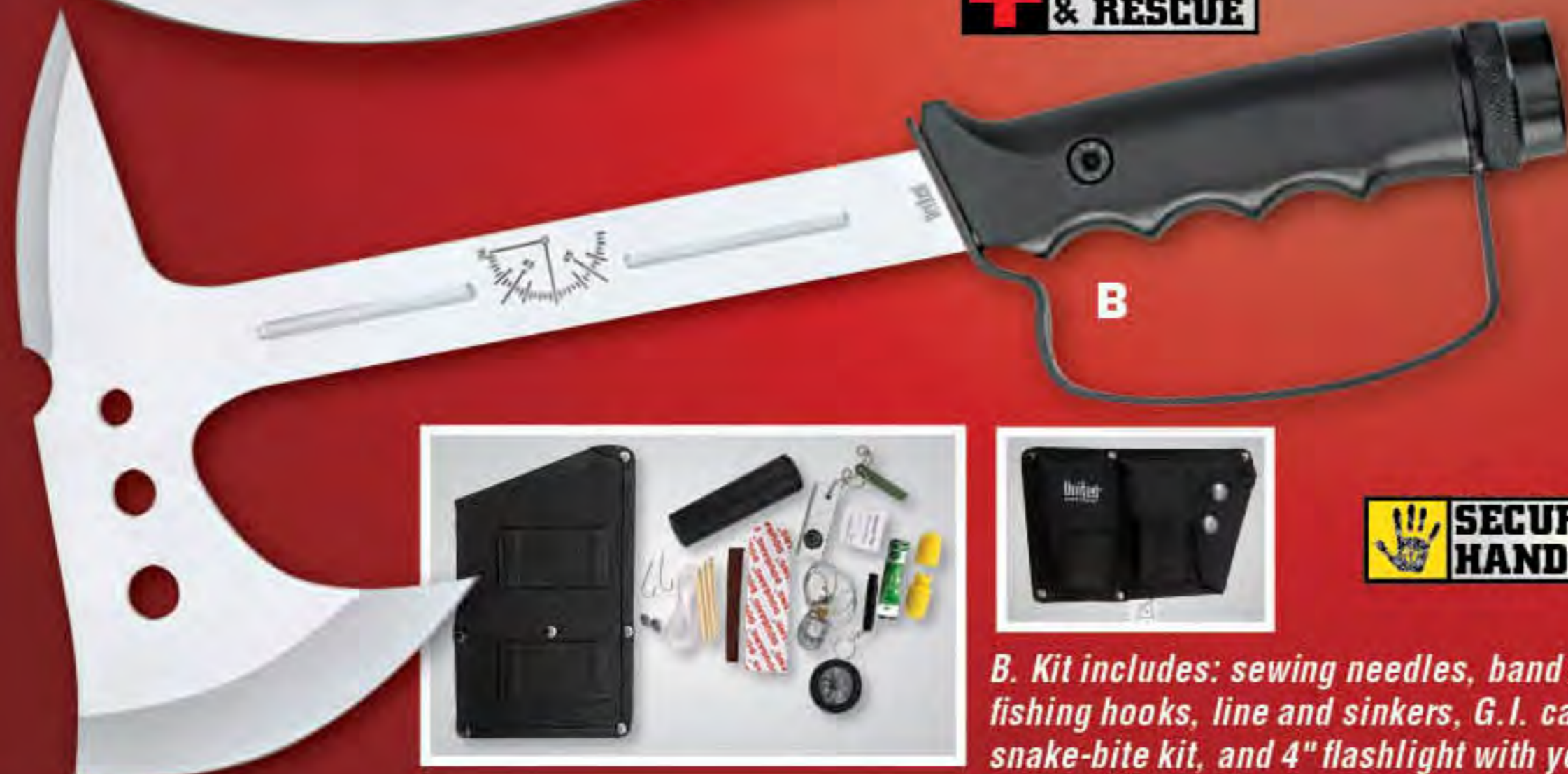

B



## Bushmaster® Survival Axe

The Bushmaster® survival axe covers all the bases, providing you with a durable tool that can tackle anything that comes your way.

### B. Bushmaster® Survival Axe

7" blade, 13 1/2" overall

#UC2962

List \$75<sup>00</sup>

**SECURE FIT HAND GRIP**

B. Kit includes: sewing needles, band aids, matches, surgical blade, magnifier, fishing hooks, line and sinkers, G.I. can opener, sharpening stone, animal snare, snake-bite kit, and 4" flashlight with yellow lanyard cord. (AA battery not included)

## Folding Survival Shovel

This versatile camping companion is easy to pack and carry along on all your outings.

- Quality tempered steel with rubber grip
- Disassembles to 6" and fits neatly into the included nylon carry pouch
- Shovel or a dibble pick option
- 16 1/8" overall when open



Serrations make sawing small branches easy.



Shovel breaks down to store easily in any pack



C. Folding Survival Shovel  
#UC8017  
List \$17<sup>00</sup>

## Sentry Black Clip Blade Knives & Shoulder Harness Sheaths

- Includes nylon sheath, fully adjustable shoulder harness, belt loop, & quick-release blade insert
- Sheath is reversible for left or right hand positions
- Razor-sharp 420 J2 stainless steel construction
- Measures: 5" blade; 9 1/2" overall
- Non-reflective black coating
- Cast metal hand guard

### D. Sentry Black Serrated Tanto Point Knife

#UC784BT

### E. Sentry Black Clip Blade Knife

#UC784

List \$30<sup>00</sup> ea.



D, E Sheath can be clipped to boot or worn on shoulder harness.



## 50 Cal. Bullet Pocket Knife

- Exact dimensions as an actual .50 cal bullet
- Polished solid brass case
- Copper-plated bullet on the tip
- 4" stainless steel blade
- 5 1/2" closed

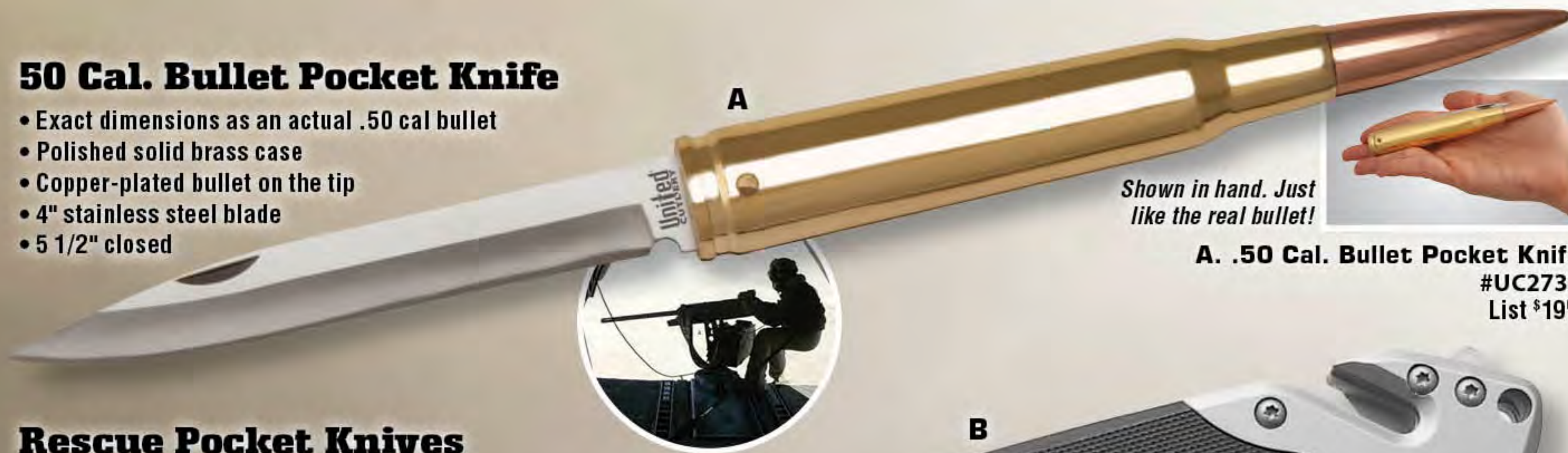

Shown in hand. Just like the real bullet!

**A. .50 Cal. Bullet Pocket Knife**  
#UC2736  
List \$19<sup>00</sup>

## Rescue Pocket Knives

- Razor-sharp stainless steel blades
- Drop point blade with thumb stud
- Steel handles with G-10 inlays
- Belt cutters & glass break spikes
- Pocket clips

### B. Camo Rescue Pocket Knife

3 1/4" bl., 8 1/2" ov.  
#UC8007  
List \$19<sup>00</sup>



**B**

**C**

**C. Warpath Rescue Folder**  
3 1/2" bl., 5" cl.  
#UC3093  
List \$20<sup>00</sup>

**NEW!**



## Metal Glo® Is The Ultimate Polish



Metal Glo® premium polishing paste is perfect for cleaning, polishing, and protecting any bare metal surface, especially stainless steel or carbon steel knife blades. 1.40 oz.

**D. Metal Glo Paste**  
#UC2723 List \$6<sup>00</sup>

## The Wahoo Killer® Dive Knife

- Razor-sharp AUS-6 stainless steel blade
- Serrated back and anti-corrosion finish
- Rubberized handle with slip-free grip
- 3" blade, 7" overall



**E**

E. Includes leg strap & locking ABS sheath



**E. Wahoo Killer® Dive Knife** #UC2897 List \$19<sup>00</sup>

## Sting Ray Dive Knife

Simply put, this is the best dive knife you will find at any price point. Strap it to your leg and dive in!

- Impact-resistant sheath with drainage hole prevents corrosion damage
- Partially serrated blade with slotted, ergonomic handle design
- One-piece AUS-6 stainless steel
- 4" blade, 8 5/8" overall

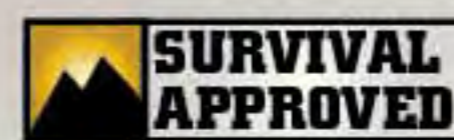

**F**



**F. Sting Ray Dive Knife** #UC0247B List \$19<sup>00</sup>

# United<sup>®</sup> DEFENSE

Whether you are current or former military personnel, law enforcement, or simply a civilian who wants to be prepared, our United<sup>®</sup> Defense line has you covered. From our daggers and blades to our best-selling tactical defense pens and paracord-wrapped monkey fists, these self-defense items are always at the ready. Each of these tactical defense items provides discreet but effective personal protection and defense. Ease of concealment, a variety of carrying options and a multitude of practical applications have brought the United<sup>®</sup> Defense line to the forefront of the personal protection and self-defense industry, and we are proud to offer the latest and best in this exclusive lineup. As always, a commitment to quality craftsmanship remains our top priority with each item.

## United<sup>®</sup> Defense Impact Batons

These heavy-duty black steel batons offer a rubberized, ridged handle for a confident grip.

- Superb balance and control • Rounded impact point
- Rapidly deployed into action with a quick flick of the wrist
- Includes a heavy-duty nylon pouch for convenient carry

A. 26" Baton  
#UC2573  
List \$48<sup>00</sup>

B. 21" Baton  
#UC2572  
List \$42<sup>00</sup>

C. 16" Baton  
#UC2571  
List \$36<sup>00</sup>



A

B

C

*Nylon sheath provides easy carry and rapid deployment of the baton when needed.*



## United<sup>®</sup> Tactical Defense Pens

Each tactical pen is precision crafted with a high quality 6061 aluminum body and high-pressure clip.

- Perfect for concealed self-defense purposes
- Excellent grip and comfortable writing style
- Fully functional writing pen

D. Black Pen  
#UC2703B

E. Silver Pen  
#UC2703  
List \$32<sup>00</sup> ea.

D

E



## Undercover<sup>®</sup> Defense Brush

Hairbrush with highly effective dagger crafted of super tough ABS, nylon, and fiberglass composite.

- 4 1/4" dagger, 9" closed

F

F. Undercover<sup>®</sup> Defense Brush Dagger  
#UC2714  
List \$13<sup>00</sup>







## United® Defense Blackthorn Shillelagh Fighting Stick

United® Cutlery has recreated the traditional Blackthorn Shillelagh fighting stick in dramatic detail with this stunning shillelagh fighting cane! Crafted in a traditional shillelagh design, complete with gnarled accents to emphasize the knotty quality of genuine blackthorn wood shillelagh sticks, this cane is molded of polypropylene with an impact-resistant faux wood cap.

- Traditional shillelagh fighting stick design
- Molded polypropylene construction
- Impact-resistant faux wood cap
- Measures 37" overall

**A. Blackthorn Shillelagh Fighting Stick**  
#UC2970  
List \$69<sup>00</sup>

**NEW!**

*Realistic details and excellent grip handle*

**INSPIRED BY HISTORY**

*Durable construction lets you smash and keep on walking with ease.*



**NIGHT WATCHMAN**



*Safety kill-switch lanyard*

## Night Watchman® 1-Million-Volt Stun Gun Flashlight

This Shocklight is an actual flashlight with 6 ultra-bright LED bulbs, but it's also a stun gun with an unheard-of, one-million-volt charge that will knock down any attacker. Attackers will think it is a flashlight until it's too late! This stun gun is even rechargeable and includes a 120v/60Hz wall charger.



- B. Night Watchman® 1 Million Volt Shocklight Stun Gun Flashlight**
- Includes wall charger and nylon case
  - Ultra-bright LED flashlight
  - Safety kill-switch lanyard
  - Rechargeable
- #UC2697

**PATENT PENDING**

- C. Night Watchman® 1 Million Volt Shocklight Stun Gun Flashlight Pink Edition**
- #UC2945  
List \$92<sup>00</sup> ea.



**C**



# BLACK RONIN™

Unlike cheap imitations, these blades from Black Ronin™ are built to the highest quality standards at unbeatable prices. This exclusive line of blades is guaranteed to deliver maximum cutting and throwing potential time and time again. Take your collection to the next level with Black Ronin™, only from United® Cutlery.

## Black Ronin™ Tactical Swords

The reinforced scabbard offers multiple carry options—sling it across your shoulder or strap it to your leg. In either case, this razor-sharp ninja sword is always at the ready. Measures: 17" blade; 27" overall.

**A. Black Ronin™ Slimline  
Ninja Sword**  
#UC1184  
List \$45<sup>00</sup>



A

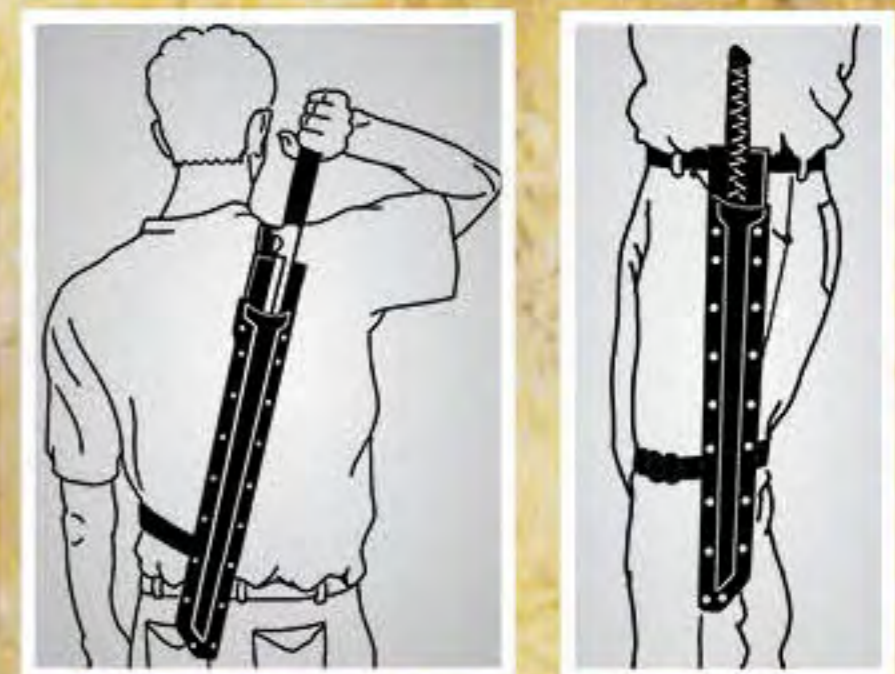

Durable multi-option carry sheath



B

## Black Ronin™ Throwers

Each thrower is one solid piece of stainless steel with razor-sharp edges & piercing points. Throw them until you get tired—they're always ready for more! Each one includes a sheath/pouch.

**B. Black Ronin™ Triple Bolt Thrower Set**  
6 1/2" overall  
#UC2802  
List \$20<sup>00</sup>



B includes nylon sheath





# SAMURAI 3000

## THE RISE OF THE SAMURAI

Each of these swords features the Samurai code of justice, service, and honor on the hand guard, engraved in their secret language. The razor-sharp blades are crafted of solid stainless steel, and the handle of these high-quality adult collectibles is made of precisely machined metal parts. The scabbard locks to the handle and can only be released with a push of the hidden button.

A

### A. Samurai 3000 Katana

Brushed satin finish  
28 1/8" katana blade  
38 1/16" overall  
#UC1258  
List \$165<sup>00</sup>

### B. Samurai 3000 Ninja Sword

Brushed satin finish  
26 1/16" double-edged blade  
36" overall  
#UC1259  
List \$165<sup>00</sup>

Samurai scabbard locks to the handle and is released with a hidden button



B

JUSTICE, SERVICE,  
AND HONOR

Patent  
D473,922  
D473,624  
©2002

## United® Cutlery Professional Throwers Are Perfectly Balanced

Take your knife-throwing skills to the professional level with these best-selling throwing knife sets exclusively from United® Cutlery.

- Razor-sharp AUS-6 stainless steel blades
- Piercing points will penetrate target effortlessly
- Ergonomic cut-out design allows for supreme accuracy and precision with each throw

**WICKED SHARP**



A. Includes nylon sheath with snap



B. Includes nylon sheath with snap



C. Includes nylon sheath with snap



- A. United® Triple Threat Thrower Black Set**  
4 1/8" blade, 8 3/8" overall  
#UC2507  
List \$59<sup>00</sup>
- B. United® Classic Triple Thrower Set**  
4 3/8" blade, 9" overall  
#UC2509  
List \$42<sup>00</sup>
- C. United® Lightning Bolt Triple Thrower Set**  
3" blade, 7 1/4" overall  
#UC2833  
List \$35<sup>00</sup>

UNITED® CUTLERY PROFESSIONAL THROWERS

## Hit Your Target Like A Lightning Bolt!

The Lightning Bolt self-defense throwing knife set features double-edged, razor-sharp AUS-6 stainless steel blades to make a deep impact on your target.

- Impact-resistant ABS sheath houses all three throwers securely with locking mechanism
- Unique cut-out pattern for an even release
- Easily concealable on belt or shoulder harness



AWARD WINNING DESIGN

### A. United® Lightning Bolt Triple Thrower Set Silver

3" blade, 7 1/4" overall  
#UC1255  
List \$37<sup>00</sup>



A

### B. United® Lightning Bolt Triple Thrower Set Black

2" blade, 5 1/2" overall  
#UC2904  
List \$30<sup>00</sup>

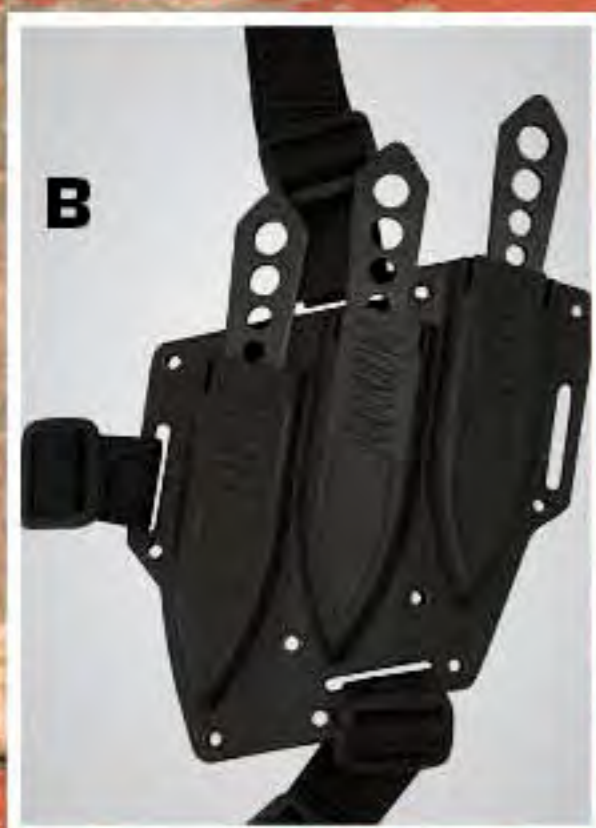

B



B

## On-Target® Game Targets & Dozen Thrower Sets

You'll enjoy less walking and more throwing with these 12-pack thrower sets. Opposing throwers feature a black baked-on finish while others are silver. Each thrower is one-piece solid stainless steel.

# ON TARGET

NEW!



C. Fantasy Skull Throwing Set  
#XL1510 List \$47<sup>00</sup>



D. Second Amendment Throwing Game  
#XL1549 List \$50<sup>00</sup>

# UNDERCOVER®

## URBAN DEFENSE

United® Cutlery's Undercover® series has been the leader in urban defense tools since it leaped onto the market. Offering a compact size and discreet carry options, these exclusive Undercover® items are easy to conceal and provide effective personal defense right at your fingertips. They'll go undetected until the second you need them, when they are quickly deployed for confident self defense. Each piece features stainless steel blades that will continue to perform over and over. Even after several years, these no-fail, self-defense tools continue to take the world by storm.

### Undercover® Magnum Push Daggers

- Double edges allow for deep penetration
- Includes nylon snap belt sheath
- Black-coated stainless steel

**A. Undercover® Magnum Push Dagger**  
3 1/2" blade, 5 3/4" overall  
#UC1488B  
List \$23<sup>00</sup>



### Undercover® Fighter

- Heavy-duty belt sheath with multi mounts
- Excellent ring grip with piercing tanto point
- Black-coated stainless steel

**B. Undercover® Fighter**  
4 3/8" blade, 8 1/2" overall  
#UC2735  
List \$27<sup>00</sup>



### Undercover® Twin Push Daggers

- Designed for quick attack
- Ergonomically designed
- Double belt sheath for comfortable carry

**C. Undercover® Twin Push Daggers**  
1 3/4" blade, 3 3/4" overall  
#UC1487 (SILVER) List \$18<sup>00</sup>  
#UC1487B (BLACK) List \$20<sup>00</sup>



Adjustable impact-resistant sheath is equipped with nylon arm/leg strap with Velcro® closure for covert use.

# RAMPAGE®

ASSISTED-OPEN

## Rampage Lightning Fast Folders

- Lightning-fast assisted-open mechanism with thumb stud & blade spur
- Textured, reinforced aluminum & ABS composite handles
- Razor-sharp 420A stainless steel blades
- Pocket clip for convenient carry

### A. Rampage® Evolution Assist Folder

3 1/8" blade, 4 1/2" closed  
#UC2965  
List \$23<sup>00</sup>

### B. Rampage® Assist Folder

3 1/8" blade, 4 1/2" closed  
#UC2726  
List \$24<sup>00</sup>

### C. Rampage® Black Stiletto

6" blade, 7" closed  
#UC2776  
List \$34<sup>00</sup>

### D. Rampage® Small Black Stiletto

4" blade, 5" closed  
#UC2885  
List \$20<sup>00</sup>

*Reinforced  
aluminum handles  
offer textured,  
contoured grips*

**LIGHTNING ⚡ FAST**

A

B



D



*B shown closed  
with clip*



*D shown closed  
with clip*

**WICKED SHARP**

*D shown in action*





United® Cutlery's popular Honshu® brand is exploding with new products this year. Leading the Honshu® lineup are the full-tang tactical tanto and katana pieces, the perfect complements to the highly sought-after Honshu® wakizashi. If covert but discreet personal protection is what you're looking for, the Honshu® karambits will answer when you call. Each of these powerful, Honshu® blades is razor sharp and features rock-solid steel construction. Each Honshu® blade comes housed in a custom, top-quality sheath for convenient carry and storage.



INSPIRED BY HISTORY

NEW!

Purchase all three Honshu® Samurai blades and receive a custom wooden Honshu® display stand **FREE!**

**WICKED SHARP**





E

**E. Honshu® 3-Piece Tactical Sword Collector's Edition**  
 Includes tanto, wakizashi and katana with display stand.  
 #UC3067  
 List \$780<sup>00</sup>

**Honshu® Full-Tang Samurai Blades Are Built To Perform!**

- Razor sharp 1060 high-carbon steel blade with deep blood groove
- Polycarbonate paracord-wrapped scabbard with storage cloth
- Non-slip checkered handle with paracord lanyard
  - Full-tang mirror-polished finish
  - Brass dowell and hand guards

**A. Honshu® Katana**  
 31 1/2" blade,  
 39" overall  
 #UC3026  
 List \$322<sup>00</sup>

**B. Honshu® Wakizashi**  
 19 3/4" blade,  
 30 3/8" overall  
 #UC2934  
 List \$242<sup>00</sup>

**C. Honshu® Tanto**  
 14 1/2" blade,  
 21 1/4" overall  
 #UC3032  
 List \$216<sup>00</sup>

**D. Now Available Honshu® Black Damascus Wakizashi**  
 19 3/4" blade,  
 30 3/8" overall  
 #UC3079  
 List \$362<sup>00</sup>





## Honshu® Sword Cane

New from Honshu®, this sword cane is a beast when it comes to self-defense! This heavy-duty sword cane offers a strong, partial crook handle constructed of injection-molded nylon with fiber for a strong, sturdy grip. The 16 3/4" blade is constructed of 2Cr13 cast stainless steel with a satin finish and a razor-sharp edge. The shaft is constructed of injection-molded nylon with fiber, just like the handle, making this sword cane virtually indestructible! The end of the shaft also features a rubber tip, making it easy to navigate through icy streets and uneven sidewalks.

- 2Cr13 cast stainless steel blade with satin finish
- Injection-molded nylon and fiber handle
- Injection-molded nylon and fiber shaft with rubber tip

A. Honshu® Sword Cane  
 16 3/4" bl., 36 7/8" ov.  
 #UC3074  
 List \$162<sup>00</sup>



937.2 mm  
 36 7/8"

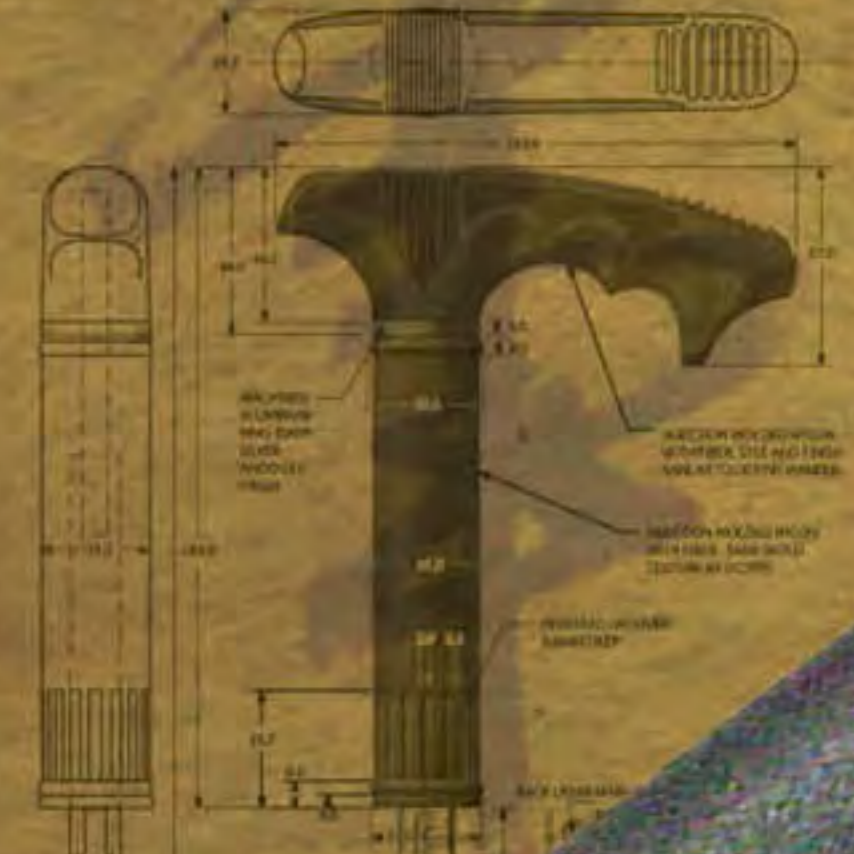

A





Artistic rendering.  
Final product may vary.

**NEW!**

**SECURE FIT  
HAND GRIP**

**Honshu® Tactical  
Karambits**

Honshu® karambits effortlessly slice through the toughest materials and provide supreme personal defense.

- Razor-sharp 7Cr13 stainless steel blade
- Discreet, effective defense weapon
- Injection-molded TPR handle with open-hole pommel for easy grip
- Includes a custom sheath



Adjustable shoulder harness with reinforced ABS sheath is designed for law enforcement professionals

**B. Honshu® Silver Karambit & Boot Sheath**  
4" blade, 8 3/4" overall  
#UC2786

**C. Honshu® Black Karambit & Shoulder Harness**  
4" blade, 8 3/4" overall  
#UC2791

**ALSO AVAILABLE:**  
**D. Honshu® Silver Karambit & Shoulder Harness**  
4" blade, 8 3/4" overall  
#UC2977  
List \$65<sup>00</sup> each



Leather boot sheath makes it easy to access the blade quickly

## Honshu® Ring Hilt Fighters

United® Cutlery has taken the Honshu® fighter to the next level with this brand new collection of fighters. Combining the power and size of a traditional fighter with the tactical applications of a karambit, each razor-sharp 7Cr13 stainless steel blade has piercing point for deep penetration. The ergonomic injection-molded handle features a ring with a spike on the end that allows you to wield it like a true ninja.

- Razor-sharp 7Cr13 stainless steel blade
- Ergonomic injection-molded handle
- Includes leather belt sheath



Each blade has a ring handle to lock in your grip

Leather sheath included



**WICKED SHARP**

**NEW!**



A

B

**SECURE FIT HAND GRIP**

C



**A. Honshu® Tanto Fighter**  
12 1/8" overall  
#UC3073  
List \$73<sup>00</sup>

**B. Honshu® Aizu Fighter Black**  
7 5/8" blade  
13 1/2" overall  
#UC3010B  
List \$73<sup>00</sup>

**C. Honshu® Aizu Fighter**  
7 5/8" blade  
13 1/2" overall  
#UC3010  
List \$73<sup>00</sup>

Each comes in a quality 4 color box



Leather sheath included



## Honshu® Spear Point Push Daggers

Each Honshu® push dagger provides discreet, effective personal protection.

- 7CR13 Stainless Steel Blades
- Quick-release leather clip sheath
- Heavy-duty textured TPR handles
- Razor-sharp double edges

**A. Honshu® Push Dagger Silver Small**  
 2 7/8" blade, 4 5/8" overall  
 #UC2868  
 List \$44<sup>00</sup>

**B. Honshu® Push Dagger Silver Large**  
 4" blade, 5 3/4" overall  
 #UC2867  
 List \$50<sup>00</sup>



*Razor-sharp fighting blade slices through tires & car seats with no resistance*





Boshin bowie shown in leather sheath with lanyard.



A

B

C

D

E

The Boshin is designed for cutting and chopping very effectively.

**WICKED SHARP**



B, C includes a quality black leather belt sheath with snap closure.

### Honshu® Fighting Blades

Each of these Honshu® designs offers a beast of a blade that is sure to perform and last for years to come. Attach a lanyard for on-the-go Honshu® power.

- Full-Tang 7CR13 stainless steel blades
- Custom embossed leather sheaths
- Heavy-duty textured TPR handles
- Razor-sharp blades
- Hefty hand guards

A. Honshu® Boshin Bowie  
9 1/4" blade, 14 7/8" overall  
#UC2935 List \$85<sup>00</sup>

B. Honshu® Mini Tanto with Sheath  
6 1/8" blade, 11" overall  
#UC2846 List \$59<sup>00</sup>

C. Honshu® Fighter with Sheath  
7 5/8" blade, 13 1/4" overall  
#UC2630 List \$74<sup>00</sup>

D. Honshu® Black Tanto with Sheath  
10 3/4" blade, 16 3/4" overall  
#UC2629B List \$74<sup>00</sup>

E. Honshu® Tanto with Sheath  
10 3/4" blade, 16 3/4" overall  
#UC2629 List \$74<sup>00</sup>





Our Colombian Sawback Machete series offers full-tang, all black beast-of-a-blade construction that not only looks mean, but can take a beating. These blades can handle any job that is put before them. Each machete features durable injection-molded handles for a firm grip in both wet and dry conditions. All of our Colombian Sawback Machetes include molded nylon sheaths, and each one of these exclusive blades is guaranteed to perform in even the toughest of conditions.

## MAKE YOUR OWN TRAIL



### Colombian Survival Spear

The Colombian Survival Spear was designed to withstand the demands of a mighty warrior. To keep up with a warrior, a spear must be indestructible and shock resistant. It must be sharp enough to pierce any object. The Colombian Survival Spear features an SK5 high-carbon steel blade with a black oxide coating and satin-finished edge that has been welded to a thick injection-molded nylon and fiberfill shaft. This spear can be used in a variety of ways but always gets the job done! Includes a heavy-duty black nylon sheath with snap button closures.

- SK5 high-carbon steel blade with black oxide coating
- Thick injection-molded nylon with fiberfill shaft
- Includes black nylon sheath

**A. Colombian Survival Spear**  
9" bl., 60 5/16" ov.  
#UC3103  
List \$147<sup>00</sup>

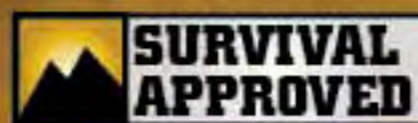

*Fine-edge blade shown with sharp sawback serrations on top of blade*

*Looped cord wrist lanyard shown on wrist*

*Each blade is equipped with enough chopping and slashing power to get any job done!*



### Colombian Sawback Machete Series

These machetes offer thick, black-coated full-tang blades that can take a beating without losing their edges.

- Heavy-duty, full-tang AUS-6 stainless steel
- Injection-molded handle offers a firm, slip-free grip
- Looped cord wrist lanyard ensures it won't stray far
- Includes molded black nylon belt loop sheath

**A. Sawback Machete**  
18" blade, 24" overall  
#UC8008  
List \$38<sup>00</sup>

**B. Kukri Machete**  
14 1/2" blade,  
21" overall  
#UC2778  
List \$38<sup>00</sup>

**C. Panga Machete**  
15" blade,  
22" overall  
#UC2819  
List \$38<sup>00</sup>



*Each Colombian machete includes a rugged nylon belt sheath with snaps*



Artistic rendering.  
Final product may  
vary slightly.

**NEW!**

**SK5**  
HIGH CARBON



COLOMBIAN  
SURVIVAL

**SK5**  
HIGH CARBON

**NEW!**

**WICKED SHARP**

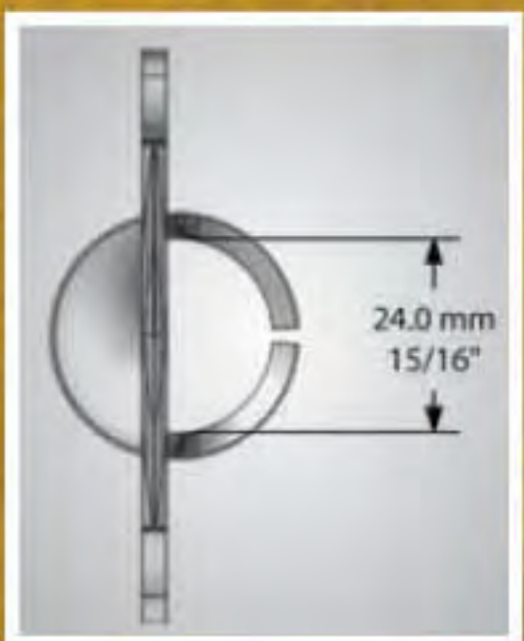

**Colombian  
Warrior Spear Head**  
This Colombian Spear Head can be attached to a wood handle and used as spear or thrusting spike. The razor-sharp blade is constructed of SK5 high-carbon steel with a black-oxide coating for a non-glare finish. This spear head will fit any standard 15/16" wooden handle.

- Fits standard 15/16" wooden handle
- SK5 high carbon steel
- Black oxide coating



Attaches to any standard wooden pole. Handle not included.

**C. Spear Head**  
6 1/8" blade, 11" overall  
#UC3122  
List \$45<sup>00</sup>

**SURVIVAL  
APPROVED**

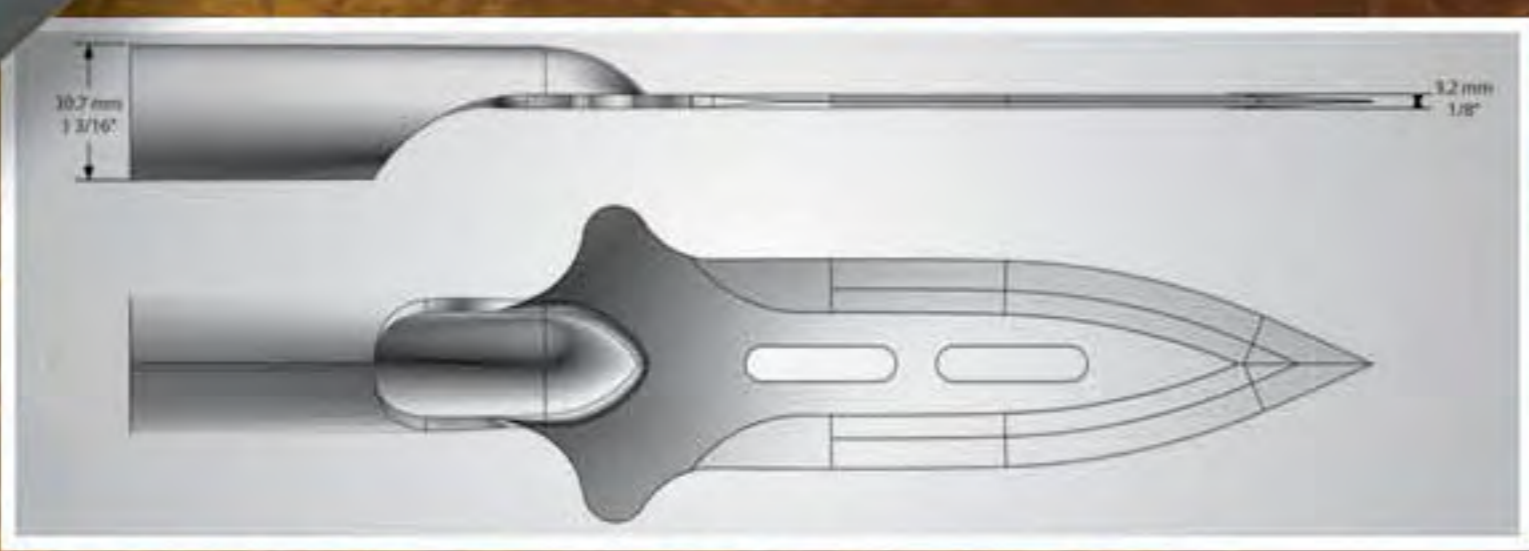

# THE HOBBIT

THE BATTLE OF THE FIVE ARMIES

United® Cutlery has meticulously crafted officially licensed prop replicas of a variety of weapons from the The Hobbit Trilogy. New to this series are reproduction props from The Hobbit: The Battle of the Five Armies, the third film in The Hobbit Trilogy. The line will consist of signature icons, such as the Mirkwood Infantry Sword, the Black Arrow of Bard the Bowman, the Regal Sword of Thorin Oakenshield and the legendary Staff of Gandalf the Grey. Each collectible is precisely replicated from the actual film props created by world-renowned physical effects house Weta Workshop for the film. In bringing these weapons of Middle-earth into the real world, close attention to detail was a top priority, and no effort was spared to make these replicas as accurate and visually stunning as possible. Each meticulously crafted collectible includes a wall display and a certificate of authenticity.

## Short Bow of Legolas Greenleaf™

Legolas Greenleaf™ is the son of Thranduil, King of the Woodland Elves. Tall and lithe, he is a lethal fighter and fiercely loyal to his father and his people, often patrolling the forest alongside the Silvan Elves of the Woodland Guard. He is as skilled with the bow as he is with his twin Elven fighting knives. An expert archer, Legolas is fluent with both the long and short bow. When traversing the dense forests of Mirkwood he prefers to use the light and lethal short bow of the Mirkwood Guard.

The Mirkwood bow reflects the natural elegance and functional artistry of the Woodland Elves, with ornately carved, overlapping leaf shapes adorning the bowstring nock tips. Natural brown and green wood colors camouflage the bow, helping the Woodland Guard blend into their environment. Includes a replica of a lethal barbed Elven arrow, a favorite used by Legolas when dispatching Orcs in Mirkwood. It was designed to inflict maximum damage to the enemies of the Woodland Realm.

- Steel reinforced polyresin with authentic details
- Mounting hardware featuring the graphic motif of the house of Thranduil
- Includes certificate of authenticity
- Hand tied bow string
- Individually serial numbered

**A. Short Bow of Legolas Greenleaf™**  
 50" overall  
 #UC3070  
 List \$457<sup>00</sup>

Poly stone wall mount display



**NEW!**

A

**NEW!**

Artist rendering.  
 Actual product may vary slightly.



Poly stone wall mount display



© Warner Bros. Entertainment Inc. All rights reserved. THE HOBBIT: THE BATTLE OF THE FIVE ARMIES and the names of the characters, items, events and places therein are trademarks of The Saul Zaentz Company d/b/a Middle-earth Enterprises under license to New Line Productions, Inc. (s15)



### Mirkwood Infantry Sword

The Mirkwood Infantry are soldiers of the Woodland Guard, Silvan Elves sworn to protect and watch over the great forest of Mirkwood, Thranduil's kingdom. They are lethal fighters and experts in the use of various weapons, including the bow and sword. The Mirkwood Infantry Sword is an elegant and deadly Silvan design, crafted with a two handed grip and Elven blade forged of Silvan steel, ornately decorated with flowing Elven designs.

- Stainless steel blade with cast metal parts and composite grip
- Includes certificate of authenticity
- Wood wall display

**B. Mirkwood Infantry Sword**  
34 5/8" blade, 47 3/8" overall  
#UC3100  
List \$360<sup>00</sup>



### Regal Sword of Thorin Oakenshield™

**NEW!**

- Polyresin construction
- Ornately sculpted raven hilt with gold accents and gold inlaid blade
- Includes 3-D poly stone wall display sculpted to match the styling of Thorin's regal war shield
- Individually serial numbered and includes a certificate of authenticity

**D. Regal Sword of Thorin Oakenshield™**  
37" overall  
#UC3106  
List \$489<sup>50</sup>

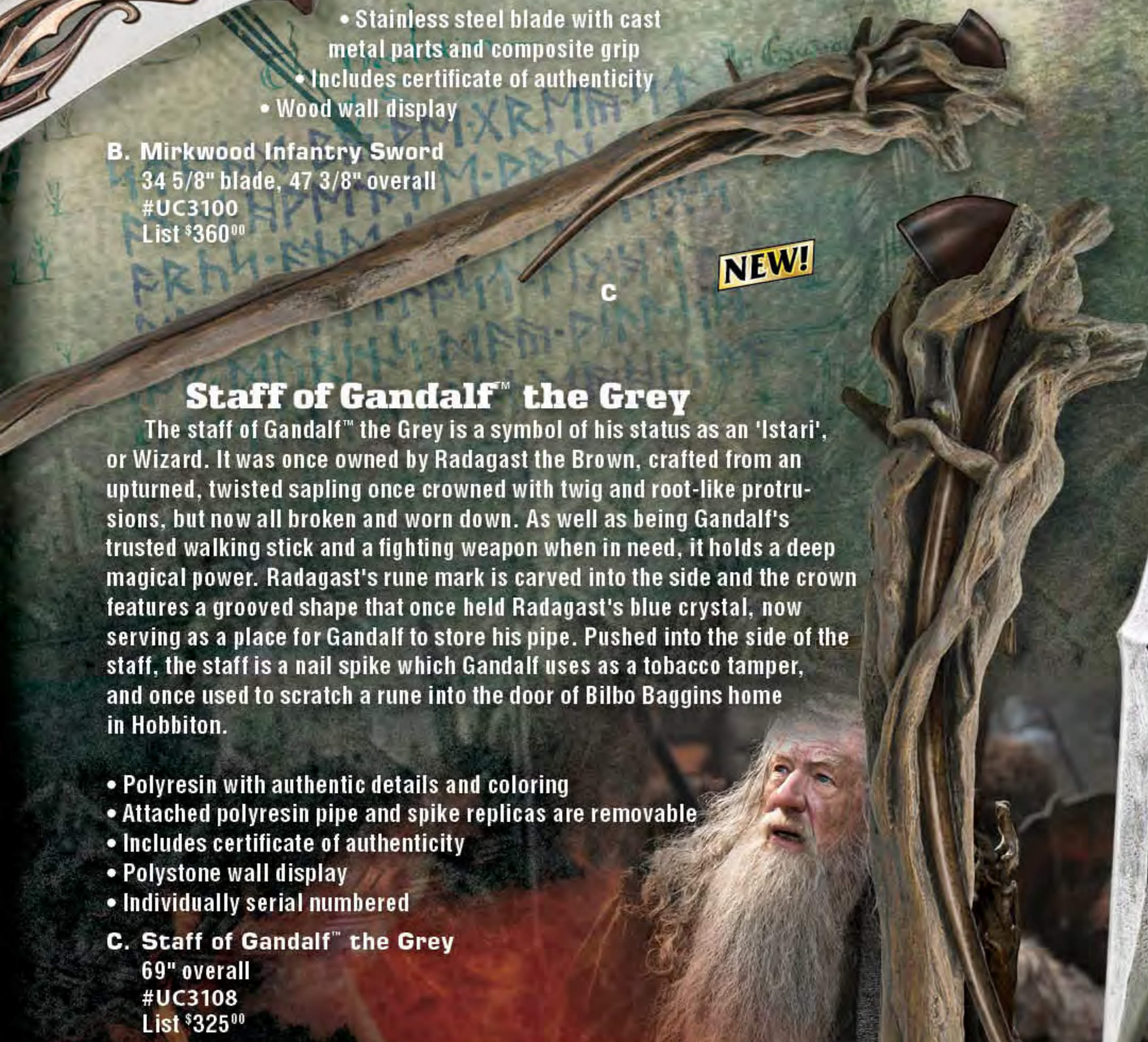

### Staff of Gandalf™ the Grey

The staff of Gandalf™ the Grey is a symbol of his status as an 'Istari', or Wizard. It was once owned by Radagast the Brown, crafted from an upturned, twisted sapling once crowned with twig and root-like protrusions, but now all broken and worn down. As well as being Gandalf's trusted walking stick and a fighting weapon when in need, it holds a deep magical power. Radagast's rune mark is carved into the side and the crown features a grooved shape that once held Radagast's blue crystal, now serving as a place for Gandalf to store his pipe. Pushed into the side of the staff, the staff is a nail spike which Gandalf uses as a tobacco tamper, and once used to scratch a rune into the door of Bilbo Baggins home in Hobbiton.

- Polyresin with authentic details and coloring
- Attached polyresin pipe and spike replicas are removable
- Includes certificate of authenticity
- Polystone wall display
- Individually serial numbered

**C. Staff of Gandalf™ the Grey**  
69" overall  
#UC3108  
List \$325<sup>00</sup>

**NEW!**



Poly stone wall mount display

## Tauriel™ Elven Bow and Arrow

Tauriel™ is a Silvan Elf and daughter of Mirkwood. A favorite of King *Thranduil* and Captain of his Woodland Guard, she is an expert fighter and extremely fast and agile in battle. Her signature weapons are twin daggers and a bow. The bow is a deadly accurate traditional recurve design used by the Woodland Guard, ornately carved with leaf motifs and hoof-shaped string nocks. United® Cutlery's replica is crafted of steel-reinforced polyresin, with precise detailing and colors to exactly match the movie prop. It is presented with a poly stone wall mount featuring a graphic motif of *Tauriel™*.

- Ornately carved with leaf motifs and hoof-shaped string nocks
- Intricately crafted of steel-reinforced polyresin
- Presented with a poly stone wall mount
- Includes Certificate of Authenticity
- Individually serial numbered

**A. Tauriel™ Elven Bow & Arrow**  
 Bow: 48" overall; Arrows: 42" overall  
 #UC3031  
 List \$457<sup>00</sup>



Poly stone wall mount display



Shown on wall display—measures 48" overall



Ornate details of bow

*Tauriel*  
 Daughter of Mirkwood



© Warner Bros. Entertainment Inc. All rights reserved. *THE HOBBIT: THE DESOLATION OF SMAUG* and the names of the characters, items, events and places therein are trademarks of The Saul Zaentz Company d/b/a Middle-earth Enterprises under license to New Line Productions, Inc. (s14)

## Black Arrow of Bard the Bowman

The Black Arrow was one of a small number forged by the Dwarves of Erebor, launched from a massive Dwarvish Windlance. When Smaug attacked the nearby city Men, Girion, the Lord of Dale attempted to slay the dragon with these giant arrows, but only succeeded in loosening one of the beast's scales. Smaug destroyed Dale and claimed Erebor, but Girion's son escaped to Laketown with the last remaining Black Arrow. His descendant Bard, a fisherman in Laketown and expert bowman, has kept it hidden should Smaug return one day.

- Crafted with a 2Cr13 cast stainless steel arrow head
- Wooden shaft and hand tied fletching
- Presented with a wood wall display with Dale motif
- Includes Certificate of Authenticity

**B. Black Arrow of Bard the Bowman**  
 7' 5/8" overall, 18" arrowhead  
 #UC3105  
 List \$274<sup>00</sup>





**NEW!**

# THE HOBBIT™

THE DESOLATION OF SMAUG

Artist rendering.  
Actual product  
may vary slightly.

C

## Staff of Thranduil

Father to Legolas Greenleaf, Thranduil is a powerful Elf-Lord and a legendary fighter. King of the Woodland Realm, he rules over the northern lands of the great forest known as Mirkwood. The staff of the Elvenking combines nature with Elven artistry. As a royal symbol of Thranduil's rule and authority over the Woodland Realm, the twisted oak shaft is crowned with an amber handle surrounded by flowing metal vine and lattice work. This replica is crafted from polyresin and presented with a poly stone wall mount featuring a graphic motif of Thranduil, and includes a certificate of authenticity.

- Presented with a poly stone wall mount with *Thranduil* motif
- Intricately crafted polyresin construction
- Includes Certificate of Authenticity
- Individually serial numbered

C. Thranduil Staff  
66 13/16" overall  
#UC3014  
List \$275<sup>00</sup>



Detail of ornate foot of staff



Poly stone wall mount display

## Fighting Knives of Legolas Greenleaf™

Although a Prince of the Woodland Realm and a High Elf, like his father Thranduil, Legolas is more likely to be found patrolling the forest alongside the Silvan Elves of the Woodland Guard than in the Court of the King. Tall and lithe, he is a lethal fighter and fiercely loyal to his father and his people. Legolas wields these twin fighting knives with incredible speed and savagery.

- Hand-shaped and finished solid wood grips with Elven vine decoration
- Razor-sharp AUS-6 stainless steel blades with Elven designs
- Solid metal guard & pommel

### A. Fighting Knives of Legolas Greenleaf™

15" blade, 22 3/8" overall

#UC3001

List \$342<sup>00</sup>



*Legolas  
Greenleaf*



Includes wood wall display



Includes wood wall display

THE HOBBIT™  
THE DESOLATION OF SMAUG

## Sword of *Thranduil*

The sword of the Elvenking was one of two twin swords crafted for *Thranduil* by the finest smiths of the Woodland Realm. The blade and flowing hilt are forged with engraved vine and leaf symbols representing the forests of the Greenwood, all forged from a single piece of silver Elven steel. This replica features a stainless steel blade and cast metal hilt with authentic detailing to precisely match the movie prop. It is presented with a wood wall display featuring graphic motif of *Thranduil*.

- Authentically detailed metal hilt and parts
- Highly detailed stainless steel blade
- Presented with wood wall mount display
- Includes Certificate of Authenticity

### B. *Thranduil* Sword

30 3/4" blade, 41 7/8" overall  
#UC3042  
List \$360<sup>00</sup>

B

Includes wood wall display

*Thranduil*

C

## Fighting Knives of *Tauriel*<sup>™</sup>

As Captain of the Woodland Guard, *Tauriel*<sup>™</sup> carries signature twin daggers with blades forged of a bronzed alloy and a Silvan steel edge of superior strength. The hilts are crafted from greenwood with bronzed steel fittings. This replica is crafted of stainless steel with cast metal and polycarbonate handles, precisely detailed and colored to exactly match the movie prop. It is presented with a wood wall mount featuring graphic motif of *Tauriel*<sup>™</sup>, and includes a certificate of authenticity.

- Stainless steel blades with cast metal & polycarbonate handles
- Wall mount display with graphic motif of *Tauriel*<sup>™</sup>
- Certificate of Authenticity

### C. Fighting Knives of *Tauriel*<sup>™</sup>

13 7/16" blade, 20 1/2" overall  
#UC3044  
List \$399<sup>00</sup>



## Rivendell Elf Helm

Hidden in a valley east of the sea was the Last Homely House, Rivendell, abode to both Sindar and Noldor Elves, and its master, Lord Elrond™. Rivendell was an outpost against the rise of the dark powers of Middle-earth. It was protected by the Rivendell Guard, who were stationed at its gates and patrolled the outskirts of the valley. The high sophistication of the Elven race was evident in the armor and helm worn by the Guard. The ancient design of the armor had been perfected long ago, dating back to the Second Age when Elrond and the High Elves battled the forces of Sauron™ on Mount Orodruin. The helm, which has the appearance of being beaten out of a single sheet of steel, is a flowing, elegant design with a high-bladed crest adorned with Elven vines. Embossed into the nose guard is an Elven sigil representing the House of Elrond.

- Intricately crafted of steel-reinforced polyresin
- Precisely-molded details and coloring
- Presented with a poly stone and wood display
- Leather chin strap
- Leather padded interior
- Includes Certificate of Authenticity
- Individually serial numbered

A. Rivendell Elf Helm  
14 7/8" x 17 1/16" overall  
#UC3075  
List \$623<sup>00</sup>



THE  
**HOBBIT**™  
AN UNEXPECTED JOURNEY



## Mace of Azog™ The Defiler

Thought to have been destroyed in the great battle between Orcs and Dwarves, Azog™ the Defiler has come forth once more, and he will stop at nothing to hunt down and destroy every last member of the company of Thorin Oakenshield™. Azog's primary weapon is his war mace. A primitive but brutal weapon, the mace was constructed of wood, leather, cord, and rough forged steel. This replica is based on the prop and models used for the film. It is crafted in steel reinforced polyresin with precise attention to detailing. It is presented with a poly stone wall mount featuring a graphic motif of Azog's tattoo scars.

- Intricately crafted of steel-reinforced polyresin
- Presented with a poly stone wall mount
- Includes Certificate of Authenticity

THE  
**HOBBIT**™  
AN UNEXPECTED JOURNEY



**B. Mace of Azog™ the Defiler**  
12 13/16" head, 40" overall  
#UC3015  
List \$490<sup>00</sup>

B

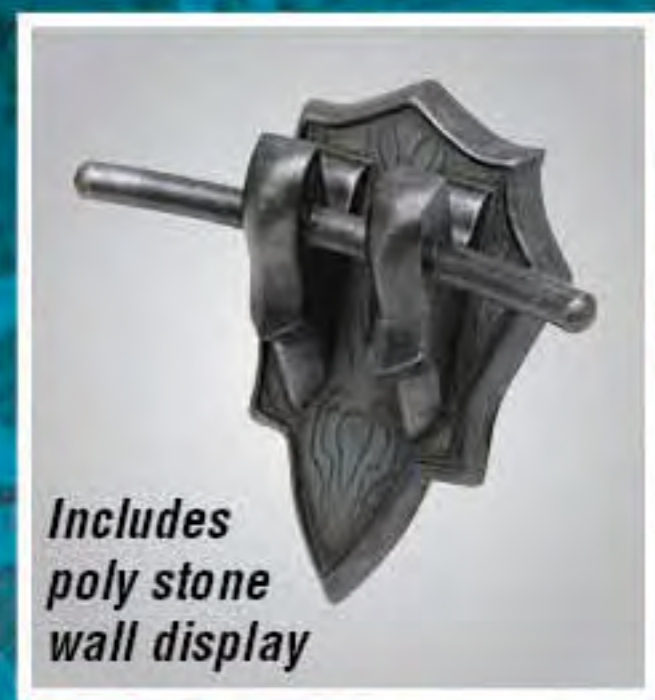

Includes  
poly stone  
wall display



**AZOG**  
THE  
DEFILER



© Warner Bros. Entertainment Inc. All rights reserved. THE HOBBIT: AN UNEXPECTED JOURNEY and the names of the characters, items, events and places therein are trademarks of The Saul Zaentz Company d/b/a Middle-earth Enterprises under license to New Line Productions, Inc. (s14)

## Illuminated Staff of the Wizard *Gandalf*™

A special edition of the Staff of the Wizard *Gandalf* with an Illuminated crown that glows just like the one seen in *The Hobbit: The Desolation of Smaug*. Features a translucent lattice within the crown that holds a high intensity white LED (100 lumens, 50,000 hour lifespan). The light is activated by a hidden button in the side of the staff and runs on two replaceable AA batteries housed on the bottom of the shaft (battery lifetime approximately 20 hours).



### A. Illuminated Staff of the Wizard *Gandalf*™

- Crafted from the molds of the actual film prop
  - Cast in hard polyresin and hand painted
  - Includes Elven-styled wall display plaque featuring *Gandalf*'s "G" rune
  - Certificate of Authenticity
  - 73" overall
- #UC3107  
List \$324<sup>50</sup>

Includes Elven-styled wall display.

All include a certificate of authenticity



**NEW!**

A

B

*Glamdring*™ details include faux blue jewel inlays and a solid metal hilt.



## *Glamdring*™ The Sword of *Gandalf*™ the Grey

*Glamdring* is an exquisite example of the height of Elven swordcraft, and a weapon befitting an Elvenking. Long lost in a Troll Hoard, the Wizard *Gandalf* recovered this ancient sword and claimed it as his own. He wielded *Glamdring* throughout the Quest for Erebor, using it against the Goblins of the Misty Mountains, and it remained his primary weapon until the end of his days in Middle-earth. The name *Glamdring* means "Foe-Hammer", and engraved into the cross guard are ancient Elvish runes that translate as "Turgon, King of Gondolin, wields, has and holds the sword *Glamdring*, foe of Morgoth's realm, hammer to the Orcs."

### B. *Glamdring*™ The Sword of *Gandalf*™ the Grey

- Deeply fullered, AUS-6 stainless steel blade
  - Solid metal hilt with faux blue jewel inlays
  - Genuine leather-wrapped grip
  - Includes wall display plaque
  - Certificate of Authenticity
  - 35 1/4" blade, 47 5/8" overall
- #UC2942  
List \$349<sup>00</sup>

Includes wall mount display



C

*Sting*

C. Includes certificate of authenticity and color box sleeve (not shown)

## *Sting*™ The Sword of *Bilbo Baggins*™

*Sting* is an ancient Elven blade discovered by *Gandalf*™ and given to the Hobbit *Bilbo Baggins*™ on his epic quest with the Company of Dwarves. *Bilbo* wielded this enchanted blade throughout his harrowing journey. This is the original version of *Sting*, before the Elvish runes and blade inscription were added.



Includes wall display



### C. *Sting*™ The Sword of *Bilbo Baggins*™

- Blade etched with flowing lines accompanied by a solid metal hilt
  - 15 3/8" blade, 22 1/4" overall
- #UC2892  
List \$224<sup>00</sup>

D

### D. *Sting*™ Sword Scabbard

- Genuine leather wrappings
  - Solid metal fittings with leather belt strap
  - Fits all officially licensed versions of the *Sting* sword produced by United® Cutlery
- 18 3/4" overall  
#UC2893  
List \$74<sup>00</sup>

*Bilbo Baggins*

## ***Orcrist* The Sword of *Thorin Oakenshield*™**

A legendary Elven blade from the First Age of Middle-earth, *Orcrist* is the sword of the Dwarven warrior *Thorin Oakenshield*™. It features a curved leaf shape on one side, and a straight edge on the other, a fitting design for a blade meant to cleave Orcs and Goblins. The grip is a dragon tooth and adorning the pommel is an emblem of an ancient Elven house, featuring four embedded jewels. Adorning the blade and guard are Elvish inscriptions that translate as "The Serpent's Tooth", and *Orcrist*, which translates as "Goblin-cleaver".

Includes Certificate of Authenticity and color box sleeve

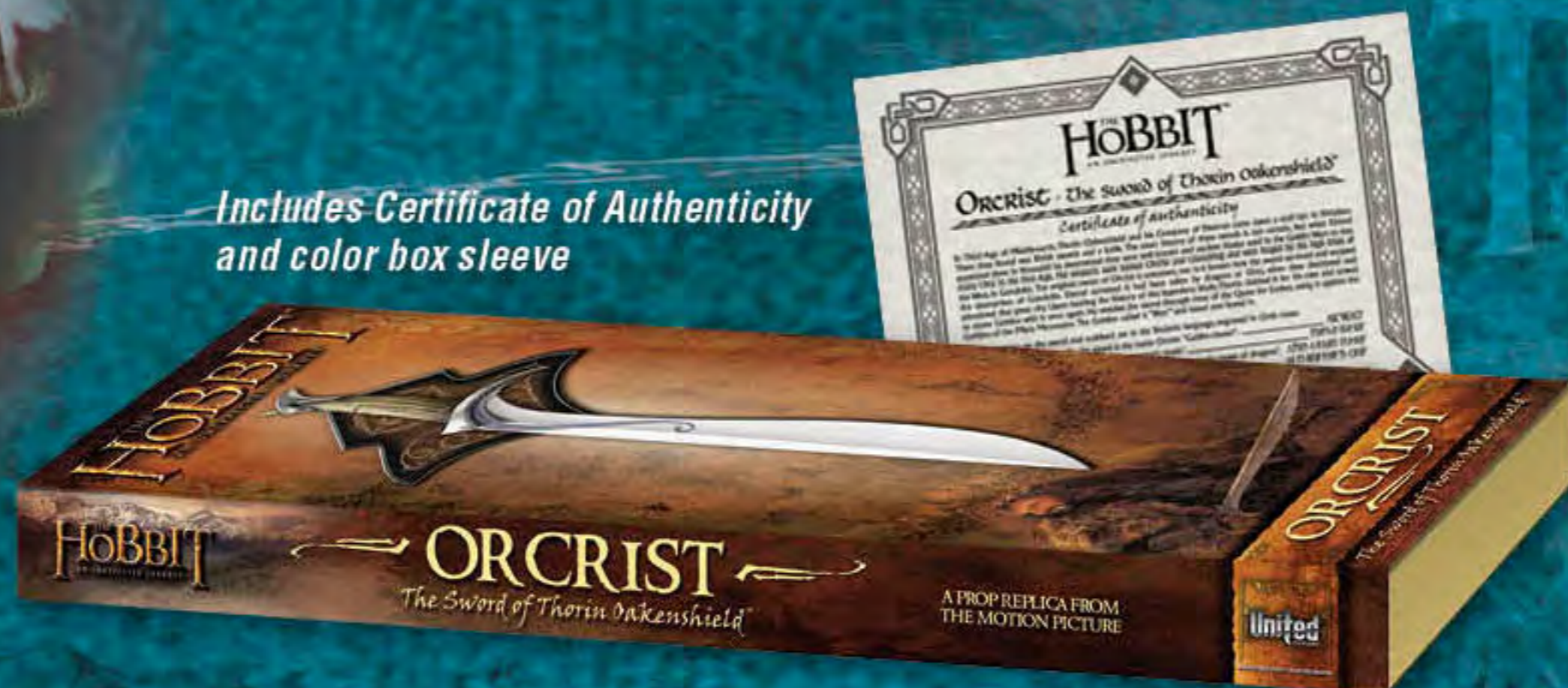

### **A. *Orcrist* Sword of *Thorin Oakenshield*™**

- Intricately detailed stainless steel blade
- Solid metal hilt with simulated gemstones
- Resin grip cast from original prop
- 25 7/8" blade, 38 3/4" overall

#UC2928  
List \$311<sup>00</sup>

### ***Orcrist* Sword Scabbard**

This authentically detailed scabbard collectible is a reproduction of the actual filming prop. The *Orcrist* Scabbard is crafted in polyresin with a metal and wood grain patterned finish, Elven vine and leaf motifs, a built-in belt loop, and felt-lined interior. Close attention to detail was a top priority, right down to the engraved runic inscriptions. Includes a certificate of authenticity.

### **B. *Orcrist* Sword Scabbard**

30" overall  
#UC2964  
List \$255<sup>00</sup>

Includes wall mount display



# THE LORD OF THE RINGS

With more than 100 million copies sold in 40 languages worldwide, millions have grown up with "The Lord of the Rings," the classic epic long considered to be one of the greatest fantasy stories ever shared. Produced by New Line Cinema, this film trilogy chronicles the struggles between good & evil for possession of the magical ring, making it one of the most popular and beloved film trilogies of the 20th century. The legendary weapons from this epic story are instantly recognizable to millions of collectors and fans around the world. United® Cutlery, industry leader in fine movie reproductions, has meticulously recreated each of these breathtaking props using only the finest grade materials and craftsmanship, and is proud to reintroduce these classic treasures in our exclusive new lineup.

## Anduril™ Sword of Aragorn™

Forged anew by the Elven smiths of Rivendell from the shards of Narsil.

### A. Anduril™ Sword of Aragorn™

- Solid metal crossguard & pommel
- Genuine leather-wrapped grip
- 24K gold-plated fittings & accents
- Solid AUS-6 stainless steel blade
- 40 5/8" blade length
- 52 7/8" overall length

#UC1380  
List \$349<sup>00</sup>



Includes wall display



A



Includes wall display.

## Sting™ Sword of Frodo Baggins™

Given to Frodo by *Bilbo Baggins™*, *Sting™* was used on Frodo's epic quest to destroy the infamous One Ring.

- ### B. Sting™ Sword of Frodo Baggins™
- AUS-6 Stainless steel blade with solid metal guard and pommel 15" blade, 22" overall

#UC1264  
List \$224<sup>00</sup>

B



## Second Age War Shield of Gondor

The great war shield carried by the soldiers of the White City of Gondor in the Last Alliance of Elves and Men! Strictly limited to 1500 pieces worldwide, each piece is individually serialized.

### A. Second Age Gondorian War Shield

- Stainless steel bands & accents
- Leather-wrapped wooden handle
- Certificate of Authenticity
- 42 1/2" x 20 1/2"
- #UC2940
- List \$463<sup>00</sup>



Authentic shield details



A

Includes wall display with Gondorian flag



Leather straps and wooden handle



© 2012 New Line Productions, Inc. All rights reserved. The Lord of the Rings: The Fellowship of the Ring and the names of the characters, items, events and places therein are trademarks of The Saul Zaentz Company d/b/a Middle-earth Enterprises under license to New Line Productions, Inc.

## Staff of Gandalf™ the White

The legendary staff used by one of the most powerful Wizards of Middle-earth, Gandalf the White.

### B. Staff of Gandalf™ the White

- Elven styled crown cast from polyresin
- Solid wood shaft (ships in 2 sections)
  - Hand-painted, bone white finish
- Stainless steel wall display mount with Gandalf rune
- Certificate of authenticity
- 72" overall
- #UC1386
- List \$237<sup>00</sup>



Includes wall display with Gandalf Rune



B



A

## Helm of King Elendil - Limited Edition

King Elendil was Isildur's father, he was the original bearer of the great sword Narsil, as seen in the prologue of the New Line Cinema motion picture *The Lord of the Rings: The Fellowship of the Ring*. This replica of Elendil's Helmet handcrafted in iron with embossed brass decorations and a weathered and distressed finish. It is fully wearable and looks great on display. The interior is lined with genuine leather for comfort and durability. Each helmet is individually serialized on a solid brass plate mounted on the inside back of the helmet to insure authenticity. Also included is a wood display stand silkscreened with "The One Ring" inscription. Limited edition of 5000 individually serialized pieces worldwide.



Serial numbered on inside of helmets

A. Helm of King Elendil  
16" overall height  
#UC1383  
LIST \$437<sup>00</sup>



NEW!



B

## Gondorian Infantry Helm - Limited Edition

The Gondorian Infantry were the proud defenders of the city of Minas Tirith, as seen in the New Line Cinema motion picture *The Lord of the Rings: The Return of the King*. This replica of the Gondorian Infantry Helm is handcrafted in iron with embossed decorations and a weathered and distressed finish. It is fully wearable and looks great on display. The interior is lined with genuine leather for comfort and durability. Each helmet is individually serialized on a solid brass plate mounted on the inside back of the helmet to insure authenticity. Also included is a wood display stand silkscreened with "The One Ring" inscription. Limited edition of 2000 individually serialized pieces worldwide.



B. Gondorian Infantry Helm  
15" overall height  
#UC1414  
LIST \$437<sup>00</sup>



NEW!

C

## Helm of King Isildur™ - Limited Edition

Isildur was the son of king Elendil, who used the broken hilt of Narsil to cut the One Ring from Sauron's finger in the prologue of the New Line Cinema motion picture *The Lord of the Rings: The Fellowship of the Ring*. This replica of Isildur's Helmet is handcrafted in iron with embossed brass decorations and a weathered and distressed finish. It is fully wearable and looks great on display. The interior is lined with genuine leather for comfort and durability. Each helmet is individually serialized on a solid brass plate mounted on the inside back of the helmet to insure authenticity. Also included is a wood display stand silkscreened with "The One Ring" inscription. Limited edition of 2000 individually serialized pieces worldwide.



C. Helm of King Isildur™  
13 1/2" overall height  
#UC1430  
LIST \$437<sup>00</sup>



**NEW!**

## Mace of Sauron™ with One Ring

A replica of the massive mace wielded by the Dark Lord Sauron in the prologue of *The Lord of the Rings: The Fellowship of the Ring*™. When Sauron's forces battled the Last Alliance of Elves and Men on the slopes of Mount Doom, Sauron emerged on the battlefield wearing blackened steel armor. In one iron gauntlet he held a massive six-bladed, black iron war mace. On one finger he wore the source of his power, The One Ring. With every swing of this terrible weapon Sauron crushed his foes, sending intimidation and fear throughout the ranks of all who would stand against him.

- Strictly Limited to 1500 Pieces Worldwide
- Steel Medallion with Serial Number
- Includes a Certificate of Authenticity

**A. Mace of Sauron™ with One Ring**  
46 3/8" overall, 15 1/2" blades  
#UC3034  
LIST \$540<sup>00</sup>



**A**

## Helm of Sauron™

The ominous war helm worn by the Dark Lord Sauron in the Last Alliance of Elves and Men! Strictly limited to 1500 pieces worldwide, each piece is individually serialized.

- Cast in hard polyresin
- Decorated to exactly match the worn iron finish of the actual filming prop
- Features a polyresin and wood base stand patterned after Sauron's upper torso armor
- Certificate of Authenticity

**B. War Helm of Sauron™**  
28 3/4" tall, 31 1/2" on stand  
#UC2941  
LIST \$624<sup>00</sup>



**B**



## Gauntlet of Sauron™

A handmade, fully functional actor-scale reproduction of the gauntlet worn by the Dark Lord Sauron in *The Fellowship of the Ring*. Strictly limited to 1000 pieces worldwide, each one is presented with a wood wall display featuring a Sauron graphic motif. Crafted of genuine leather and iron, the gauntlet features more than 35 plate mail parts with an iron black finish and Intaglio surface engraving. Includes the One Ring with inscription, crafted in gold-plated metal.

- Iron black finish with Intaglio surface engraving
- Crafted of genuine leather and iron
- Gold-plated metal accents
- Presented with wall mount display
- Certificate of Authenticity

**C. Gauntlet of Sauron™**  
13 1/4" overall  
#UC3065  
LIST \$620<sup>00</sup>



**C**



© 2014 New Line Productions, Inc. All rights reserved. The Lord of the Rings: The Fellowship of the Ring and the names of the characters, items, events and places therein are trademarks of The Saul Zaentz Company d/b/a Middle-earth Enterprises under license to New Line Productions, Inc.



Kit Rae is one of the foremost fantasy and collectible weapon designers in the industry, with a worldwide following of his unique weapon designs and fantasy art. Images from a hidden world of dreams and nightmares inspire this line of edged creations, exclusively manufactured by United® Cutlery. Since 1984, Kit's fantasy knives and swords have appeared in numerous films and television shows, and have spawned the creation of a huge worldwide, collectible market for fantasy weapons that has generated numerous imitators. His most well-known creation is the world-renowned, best-selling Swords of the Ancients™ collection. All of Kit's edged fantasy weapons include a companion print of his fantastic artwork and a mythology about each weapon.

## Kit Rae® Mithrokil Short Swords

The latest in the Swords of the Ancients collection! Mithrokil is the short sword of the ancient Mithrodim warrior Kethol Av Torketal (from the Swords of the Ancients mythology). Full tang, tempered one-piece 3Cr13 stainless steel construction, the blade is adorned with a silk-screened vine design and the grip is wrapped in genuine leather. This short sword is available in either a jet-black or satin finish. Each sword is marked with the Kit Rae emblem and includes a certificate of authenticity.

- Tempered 3Cr13 stainless steel construction
- Genuine and imitation leather scabbard
- Vine design blade decoration
- Genuine leather wrapped grip

### A. Kit Rae® Mithrokil Short Sword Satin

15 1/2" blade,  
25 1/8" overall  
#KR0066  
List \$90<sup>00</sup>

**NEW!**







### Kit Rae® Vorthelok Sword

From the Swords of the Ancients collection, Vorthelok features a stainless steel blade (false edged), engraved runes, finely detailed cast metal hilt parts with "antiqued iron" metal finish, and a waxed cotton cord wrapped grip. Includes a certificate of authenticity and a custom art print depicting Vorthelok.

- False edged stainless steel blade
- Detailed cast metal hilt parts
- Waxed cotton cord wrapped grip
- Certificate of Authenticity
- Custom Vorthelok art print

**B. Kit Rae® Vorthelok Sword**  
28" blade 45" overall  
#KR0046  
List \$276<sup>00</sup>



A. Includes custom art print, "Receiving Vorthelok"



### Kit Rae® Axios Sword Canes

These forged sword canes from Kit Rae® abound with scrupulous details throughout their exceptional design. The razor-sharp blades feature intricate scrollwork etchings. The blades lock securely into the cane shaft with a secure locking mechanism, and are unlocked with a push of the hidden button.

- Choice of 1045 carbon or Damascus steel
- Wooden shaft with a cast metal fitting
- Genuine leather wrapped handles
- Cast metal handle and fittings

**C. Axios 1045 Carbon Steel Cane**  
22 7/8" blade,  
37 1/2" overall  
#KR0056  
List \$220<sup>00</sup>

**D. Axios Folded Damascus Cane**  
22 7/8" blade,  
37 1/2" overall  
#KR0056D  
List \$292<sup>00</sup>

## Ellexdraw™ War Spear

Ellexdraw™ is the spear of the 200 year old Mithrodin master, Kethol av Torketal, who changed the tides of battle in the Red War by throwing his spear and piercing the heart of The Dark One, securing his defeat (from the Swords of the Ancients mythology).

- Two 3Cr13 stainless steel blades with a blackened steel shaft
- Leather wrapped grips & finely detailed solid metal fittings
- Serial numbered with laser-engraved Kit Rae® emblem
- Includes a custom art print & Certificate of Authenticity

### A. Ellexdraw™ War Spear

18 1/2" blades, 71" overall

#KR0050

List \$162<sup>00</sup>



All art and design  
copyright Kit Rae®.



Ellexdraw™ includes custom  
art print, "The Red War"



### B. Kit Rae® Universal Sword Plaque

A unique way to showcase  
your favorite swords. Solid  
wood with screen print.  
15" x 9" overall.

#KR0062

List \$35<sup>00</sup>



Includes Kit Rae® custom art print

## Mithrodin® Sword

The battle sword of the elite Mithrodin warriors in ancient times features a curved, false-edged blade of 3Cr13 stainless steel with engraved runes, highly detailed solid metal hilt parts and a genuine leather wrapped grip. Includes a certificate of authenticity and custom art print.

- A. Kit Rae® Mithrodin® Sword**  
42 3/4" overall  
23 3/4" blade  
#KR0025  
List \$199<sup>00</sup>

A



B

Fits Mithrodin, Avoloch, and Vorenthul swords

- B. Kit Rae® Sword Wall Display**  
Wood construction with brass Kit Rae® shield. Includes mounting hardware.  
Fits KR25, KR38, KR54  
#KR0041  
List \$33<sup>00</sup>

C

## Black Legion Battle Axe

The primary weapon of the Barumen Axe Men, monstrous soldiers of Vardor, Lord of the Shadows. Deep etched 3Cr13 stainless blades (false edged), solid metal handle parts, leather wrapped grip. Includes custom art print, "The Barumen".



- C. Kit Rae® Black Legion Battle Axe**  
22 3/4" blade  
42 3/4" overall  
#KR0022B  
List \$235<sup>00</sup>

Includes Kit Rae® custom art print

## Perfectly Balanced AirCobra® Throwers from Kit Rae®

Kit Rae is well known for his fantasy swords and blades, but Kit has also been an avid throwing knife enthusiast for many years. These throwing knives are constructed of one solid piece of stainless steel with a balanced handle-to-blade design for perfect throwing. Each set includes a nylon belt sheath for carry or storage.

- One-piece solid 3Cr13 stainless steel construction
- Razor-sharp blades with piercing points
- balanced handle to blade design
- custom storage sheaths

**SECURE FIT  
HAND GRIP**

Full-color target  
included with items  
A, B, & C



- A. Kit Rae® AirCobra®  
Black 10 3/8" Triple Set  
#47 KR0061 List \$70<sup>00</sup> ea.
- B. Kit Rae® AirCobra®  
9" Triple Set  
#KR0059 List \$69<sup>00</sup> ea.
- C. Kit Rae® HellHawk®  
Black 9 3/4" Triple Set  
#47 KR0057  
List \$69<sup>00</sup> ea.



Each throwing set on this page  
includes a nylon belt sheath.

**WICKED SHARP**



## Aircobra® Throwing Axes

- Balanced handle to blade design for precision
- One-piece solid stainless steel construction
- Razor-sharp blade and piercing point
- Leather wrappings on handle
- Leather blade sheath

**A. Kit Rae® AirCobra®  
Throwing Axe**  
4 3/8" blade, 10 3/4" overall  
#KR0055  
List \$74<sup>00</sup>



*B Includes custom sheath and box design*



## BlackJet® Throwers

Each thrower is constructed from one piece of solid tempered stainless steel with a perfectly balanced blade to handle design. Each one is razor sharp. Includes custom fitted leather sheath.

**B. Kit Rae® BlackJet®  
Throwing Axe**  
14 5/8" overall  
#KR0036B  
List \$35<sup>00</sup>

**C. Kit Rae® Silver BlackJet®  
10 3/4" Throwing  
Dagger Triple Set**  
#KR0035  
List \$71<sup>00</sup>

**D. Kit Rae® BlackJet® 10 1/2"  
Triple Thrower Set**  
#KR0032B  
List \$71<sup>00</sup>



**LIGHTNING FAST**





As the creator of some of the most widely recognized knives in the industry today, Gil Hibben's knowledge and 50 years of experience are unprecedented in the world of custom knife making. He is the creator of the popular Rambo™ III bowie and Rambo™ IV machete, each specially made for the Sylvester Stallone films, and knives for other Hollywood productions and personalities, such as John Wayne, Elvis Presley, Steve McQueen, and Steven Seagal. He created the Klingon blades for the "Star Trek Experience" in Las Vegas, and he is the "Official Klingon Armourer" for Paramount Pictures.

Gil produced knives for our servicemen to use in Vietnam, and his first-hand experience as an Alaskan hunting guide, throwing knife expert, and sixth-degree black belt in Kenpo Karate have contributed to his creating some of the most popular knives of the 20th Century. Mr. Hibben was inducted into the Knife Throwers Hall of Fame in October 2003 for his many contributions to throwing knife designs. United® Cutlery is proud to offer production knives based on Gil's custom designs. This top-selling brand consists of throwing knives, hunting knives, personal protection knives, and the most collectible line of production fantasy available today.



## Hibben™ Sub Hilt Toothpick

New this year from Gil Hibben is the Sub Hilt Toothpick fixed-blade knife. This hefty combat-style knife is both attractive and functional, backed by the Hibben™ name.

- 7Cr13 stainless steel blade
- Stainless steel guard, sub hilt and pommel
- Black Micarta grip with stainless spacers
- Includes leather sheath

**NEW!**

### A. Hibben™ Sub Hilt Toothpick

10 7/8" blade, 16" overall

#GH5044

List \$162<sup>00</sup>



**WICKED SHARP**

A



Saws through tough branches

*Gil Hibben*

## The Gil Hibben™ Sawback Survival Tanto

The latest in Gil Hibben's custom knife lineup, this Gil Hibben™ Survival Tanto is a brand new design, featuring a heavy double-serrated backside and piercing tanto point. The razor-sharp blade is crafted of 7Cr17 stainless steel with a non-reflective coating and oversized guard. The hollow handle is wrapped in cord and accessed when you remove the screw-on aluminum end cap, which features a built-in compass. Includes leather sheath.

- Razor-sharp 7Cr17 stainless steel blade
- Heavy double-serrated backside
- Non-reflective coating
- Cord wrapped handle
- Leather sheath



Attach to a limb for extended reach!

**B. Gil Hibben™ Survival Tanto**  
 9 1/2" blade,  
 14 1/4" overall  
 #GH5040  
 List \$130<sup>00</sup>

**B**

Includes leather belt sheath

End cap features built-in compass



Powerful full-tang construction

## Alaskan Survival Knife

This knife design has been used and fully endorsed by the prestigious Alaskan Professional Hunters Association. Features a black Micarta handle, stainless steel guard and pins, and an AUS-6 stainless steel blade. Also includes a premium leather sheath.

**C. Gil Hibben™ Alaskan Survival Knife**  
 6 7/8" blade, 12 1/4" overall  
 #GH1168  
 List \$97<sup>00</sup>

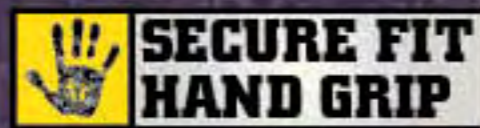

Includes custom leather sheath

## The Hibben™ Survivor Bowie

This massive knife offers a 10" AUS-6 stainless steel blade with powerful, double-serrated sawback teeth. The black Pakkawood handle offers a solid, ergonomic grip with a cast aluminum pommel and hand guard. Includes a custom embossed leather belt sheath.



**A. Gil Hibben™ Survivor Bowie and Sheath**  
10" blade, 15" overall  
#GH5026  
List \$161<sup>00</sup>



**SECURE FIT HAND GRIP**

HIBBEN CUSTOM DESIGN SERIES  
**HIBBEN KNIVES**



## Gil Hibben™ Assault

The Assault offers a 7 1/2" razor-sharp 7Cr17 stainless steel clip-point blade with a premium Micarta handle, accented with nickel silver pins and lanyard hole. The guard, pommel and fittings are crafted of polished cast aluminum. Includes a custom embossed leather belt sheath.

**B. Gil Hibben™ Assault with Sheath**  
7 1/2" blade, 12" overall  
#GH5025  
List \$119<sup>00</sup>



**NEW!**

## Hibben™ Old West Boot Knife

- Mirror-polished stainless steel blade
- Classic hardwood handle
- Includes boot clip sheath

**C. Gil Hibben™ Old West Boot Knife**  
6 1/2" blade, 10 5/8" overall  
#GH5047  
List \$72<sup>00</sup>



*Gil Hibben*

**HIBBEN KNIVES**  
• CUSTOM DESIGN •



## Gil Hibben™ Custom Sword Canes

These sword canes offer a 36 1/2" wooden shaft with custom handle designs. The 14" mirror-polished 7Cr13 stainless steel tanto blade snaps into the shaft and releases with a blade-release mechanism built into the handle. They can also be utilized as a club for self defense.

*Gil Hibben*  
**HIBBEN KNIVES™**  
 "CUSTOM DESIGN"

- A. Gil Hibben™ Custom Hook Sword Cane**  
 14" blade, 36 1/2" overall  
 #GH5036  
 List \$185<sup>00</sup>

**A**  
 Custom hook handle design features intricate wire wrappings.

## Gil Hibben™ Highlander Bowie

This classic stainless masterpiece was designed with the ancient highlanders in mind. The solid AUS-6 stainless steel blade, guard and pommel are mirror polished, with a stainless, wire-wrapped handle for a sleek, sure grip. Includes an embossed leather belt sheath.



Includes custom leather sheath

- B. Gil Hibben™ Highlander Bowie**  
 8 3/4" blade, 13 1/2" overall  
 #GH627  
 List \$93<sup>00</sup>

INSPIRED BY HISTORY

**B** **WICKED SHARP**

## Gil Hibben™ Annuals Are Reborn

Due to strong customer demand, these superb knives are making a return. Among the first to appear in his annual Fantasy Series, the Shadow collection was designed by Gil Hibben in the early 1990s.

- Mirror-polished AUS-6 stainless steel blades
- Wire-wrapped handles provide a sure grip
- Gil Hibben™ blade etchings
- Custom embossed leather sheath



B-D include genuine leather sheaths

- C. Gil Hibben™ Silver Shadow**  
 7 1/2" blade, 12 1/2" overall  
 #GH0441  
 List \$67<sup>00</sup>

- D. Gil Hibben™ Silver Shadow II**  
 4 1/8" blade, 9 3/4" overall  
 #GH0751  
 List \$59<sup>00</sup>

- E. Gil Hibben™ Double Shadow**  
 6" blade, 11 1/2" overall  
 #GH0453  
 List \$77<sup>00</sup>

## The Hibben™ Combat Series

Hibben™ knives are built to last, and the Combat Series is not an exception. Each knife is constructed of stainless steel with handsome laminated wood handles. Each includes a genuine leather sheath.

- Hefty AUS-6 stainless steel blades
- Handsome laminated wood handles
- Custom leather sheaths

**A. Gil Hibben™ IV  
Combat Machete**  
17 1/2" overall  
#GH5008  
List \$165<sup>00</sup>

**B. Gil Hibben™ III**  
16" overall  
#GH201  
List \$165<sup>00</sup>

**C. Gil Hibben™ III  
Fighter**  
13" overall  
#GH5005  
List \$109<sup>00</sup>

**D. Gil Hibben™  
HTF Recon**  
10" overall  
#GH5001  
List \$119<sup>00</sup>



A-C Include custom leather sheaths with leg straps

**SURVIVAL  
APPROVED**

**WICKED SHARP**



D. Includes genuine leather sheath

## The Hibben™ Claw II

This classic hand claw features solid AUS-6 stainless steel construction with an ergonomic, cut-out handle design. Includes a custom leather sheath.

- A. **Gil Hibben™ Claw**  
2 3/4" blade, 6" overall  
#GH2028SS  
Also Available  
BLACK #GH2028SSB  
List \$42<sup>00</sup> ea.



Custom design allows for a variety of handling options



**SECURE FIT  
HAND GRIP**



## Gil Hibben™ GenX Pro Throwers

Each thrower is constructed of one solid piece of tempered AUS-6 stainless steel with an ergonomic handle design for a consistent and accurate release with each throw. Each set includes a custom nylon storage sheath.

- B. **Gil Hibben™ Large GenX Pro Thrower Triple Set**  
5 3/4" blade, 11" overall  
#GH5029  
List \$74<sup>50</sup>
- C. **Gil Hibben™ Small GenX Pro Thrower Triple Set**  
3 3/4" blade, 7" overall  
#GH5030  
List \$45<sup>50</sup>

**LIGHTNING FAST**



HIBBEN CUSTOM  
DESIGN SERIES  
**HIBBEN KNIVES**

# Gil Hibben™ Competition Pro Throwers

Endorsed by the International Knife Throwers Hall of Fame, these competition throwers are available in your choice of large or small sizes.

## A. Large Competition

**Triple Set**  
12 1/8" overall  
#GH2033  
List \$74<sup>50</sup>

## B. Small Competition

**Triple Set**  
8 1/2" overall  
#GH2034  
List \$61<sup>00</sup>



Pro Throwers (A) and (B) include 18" x 18" paper competition target

## C. Gil Hibben™ Throwing Guide

The recently updated Hibben™ professional guide to throwing offers 64 pages of detailed & instructional, full-color illustrations for the beginner or the seasoned professional knife thrower.

#UC0882  
List \$10<sup>00</sup>

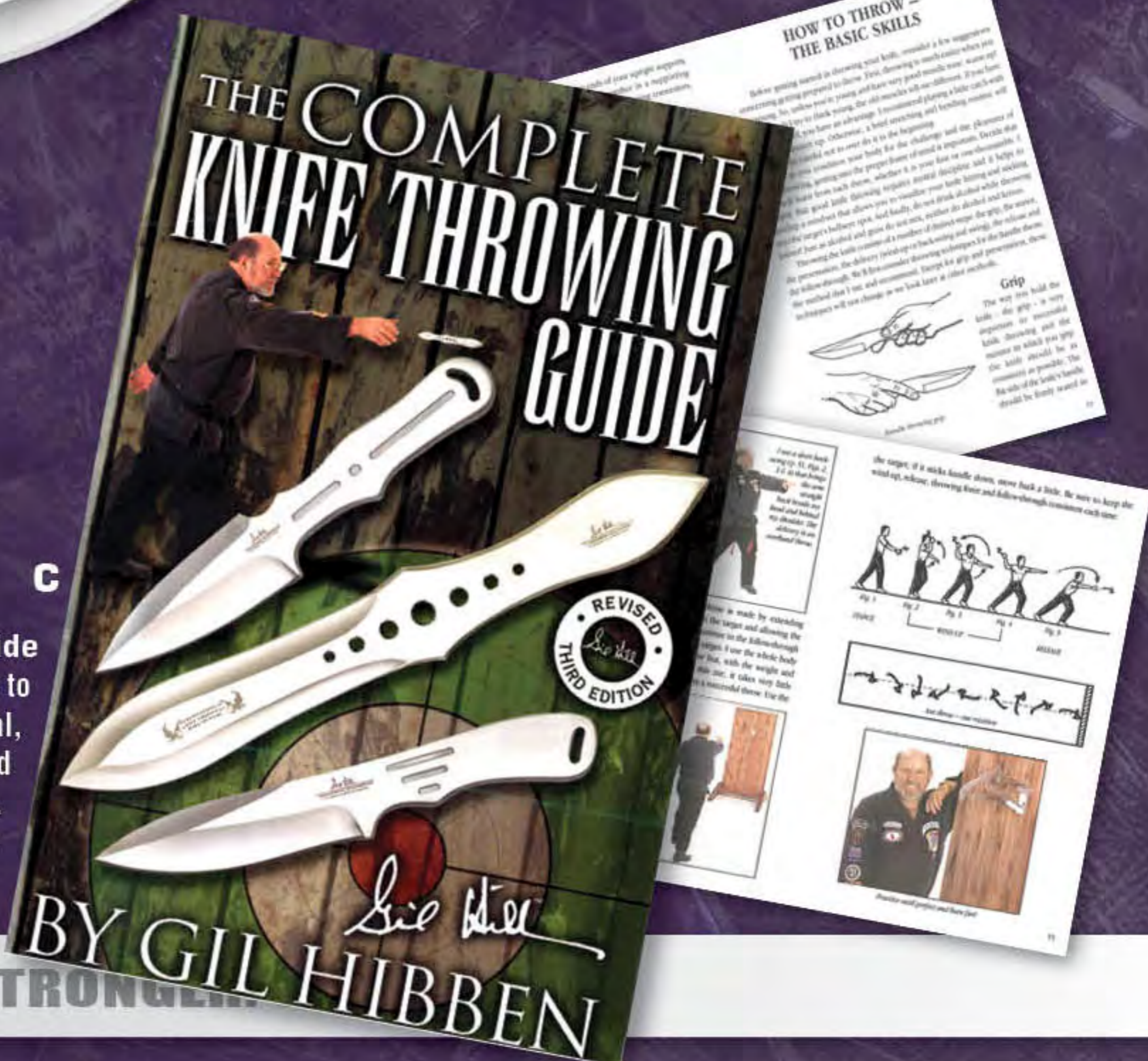

## Gil Hibben™ Pro Thrower Axes

These custom throwers are perfectly balanced with one-piece tempered AUS-6 stainless steel construction and designed for a consistent and accurate release each time they are thrown. Each includes a leather sheath.

**NEW!**

**A. Hibben™ Pro Gen X Pro Throwing Axe**  
5 7/8" bl, 12" ov.  
#GH5043  
List \$63<sup>00</sup>

**B. Hibben™ Pro Thrower Axe**  
12" overall  
#GH0866  
List \$62<sup>00</sup>



**LIGHTNING FAST**

*Gil Hibben*

## Gil Hibben™ Stonewashed Professional Large Throwing Knives

Gil Hibben updates a long-time classic Hibben™ favorite in these professional large throwing knives, now with a contemporary stonewash finish. Each 8-1/2" thrower features one-piece stainless steel construction, and the new stonewash finish gives a refreshing, modern look and feel to these classically designed throwers while staying true to their proud Hibben™ lineage. The handles feature cord wrappings for a superb grip, and the well-balanced weight ensures a good release with every throw. Watch these boys sail right into your target every time!

- One-piece stainless steel construction
- Contemporary stonewash finish
- Cord-wrapped handles
- Includes nylon sheath
- 8 1/2" overall length

**C. Stonewashed Professional Large Throwing Knives**  
8 1/2" overall  
#GH5048  
List \$53<sup>50</sup>

*Shown in sheath*



*Gil Hibben crafting a master blade*



## Gil Hibben™ Pro Throwers

Each throwing knife is constructed from one solid piece of AUS-6 stainless steel with a variety of attractive handle and blade designs and sizes.



- |   |   |
|---|---|
| <b>F. Large Triple Tanto Set</b><br>11 5/16" overall<br>#GH5003<br>List \$74 <sup>00</sup>  | <b>J. Gen II Large Triple Set</b><br>8 5/8" overall<br>#GH2011<br>List \$63 <sup>00</sup>   |
| <b>G. Small Triple Tanto Set</b><br>7" overall<br>#GH5002<br>List \$46 <sup>00</sup>        | <b>K. Gen II Small Triple Set</b><br>7 1/8" overall<br>#GH2005<br>List \$44 <sup>00</sup>   |
| <b>H. Original Large Triple Set</b><br>8 1/2" overall<br>#GH0455<br>List \$67 <sup>00</sup> | <b>L. Gen II Pro Throwing Combo</b><br>8 1/4" overall<br>#GH2007<br>List \$53 <sup>50</sup> |
| <b>I. Original Small Triple Set</b><br>6 1/8" overall<br>#GH0458<br>List \$46 <sup>00</sup> |   |



**WICKED SHARP**

## Cord Grip Throwers

Constructed of one solid piece of AUS-6 stainless steel, these custom throwers are perfectly balanced for precision and accuracy, with nylon cord wrappings on the handles. Each set includes a nylon sheath.

- |  |   |
|--|---|
| <b>M. Large Cord Grip Triple Set</b><br>8 5/8" overall<br>#GH0947<br>List \$55 <sup>00</sup> | <b>N. Rainbow Triple Pro Throwing Set</b><br>8 5/8" overall<br>#GH5042<br>List \$55 <sup>00</sup> |
| <b>O. Small Cord Grip Triple Set</b><br>6 1/4" overall<br>#GH0949<br>List \$37 <sup>00</sup> |   |



**NEW!**



*Sie Hill Wesley & Hibben*

**HIBBEN LEGACY**  
• CUSTOM DESIGN •

## The Hibben™ Legacy Collection

Gil and Wesley Hibben have teamed up to create the latest masterpieces to bear the Hibben name. Bringing more than 75 years of combined knife-making experience, this collaborative Legacy Hibben Fighter collection epitomizes their innovative vision and continues the proud Hibben legacy. No detail has been overlooked!

**NEW!**

- Razor-sharp stainless steel blades
- Handsome contoured handles
- Exclusive signature etchings
- Embossed leather sheath

**A. Legacy III Fighter**  
7" blade, 12 1/2" overall  
#GH5049  
List \$149<sup>50</sup>

**B. Legacy II Fighter**  
8" blade, 13 3/8" overall  
#GH5039  
List \$117<sup>00</sup>

**C. Legacy Bowie**  
5 7/8" blade, 12" overall  
#GH5027  
List \$93<sup>50</sup>



Includes custom leather sheath



Includes custom leather sheath

Includes custom leather sheath

Custom knifemakers Gil and Wesley Hibben bring decades of experience to the table



## Hibben™ Legacy Four-Piece Throwing Knife Set

Gil and Wesley Hibben continue their proud legacy collaboration with this brand new four-piece throwing knife collection that was inspired by THE EXPENDABLES 3. Each of the four throwers features hefty one-piece stainless steel construction with a sharp edge and a piercing point to penetrate your target easily. The two Gil Hibben™ 8-5/8" throwers feature cord-wrapped handles while the two oversized Wesley Hibben™ 10-1/8" throwers have an uncovered, ergonomically machined handle. All four come to you in a sturdy nylon sheath.

- Stainless steel construction • Sharp blades and piercing points
- Autographed laser etchings • Includes nylon sheath

**A. Hibben™ Legacy Throwing Set**  
 2-8 5/8" throwers, 2-10 1/8" throwers  
 #GH5046  
 List \$89<sup>50</sup>



*Includes a custom nylon sheath with multi-carry options*



**B. Wes Hibben™ Brother's Keeper®**  
 12 1/2" overall  
 #WH103  
 List \$117<sup>00</sup>

*Wesley Hibben*



*Includes custom leather sheath*



## Wes Hibben™ Brother's Keeper®

The latest in Wes Hibben's signature line, this Brother's Keeper® Bowie will leave you speechless.

- 7Cr17MoV stainless steel blade
- Non-reflective blade coating
- Premium Micarta handle
- Heavy guard & pommel
- Embossed leather belt sheath



*Includes custom leather sheath*



*Perfectly balanced for throwing*



*B, C Includes nylon sheath*

**LIGHTNING FAST**



## Wes Hibben™ Cloak® Throwing Knife Collection

With sleek, futuristic styling, these custom throwing pieces not only look great, but throw perfectly as well. Each piece is constructed from one solid piece of 5mm-thick AUS-6 stainless steel with a corrosion-resistant, non-glare black coating. Each has been laser etched with the Wesley Hibben™ Custom Design logo and the handles feature grooves for aerodynamic performance.

**C. Wes Hibben™ Cloak® Series Throwing Axe**  
 7" head, 13 7/8" overall  
 #WH100  
 List \$72<sup>00</sup>

**D. Wes Hibben™ Cloak® Large Triple Throwing Set**  
 4 5/8" blade, 10" overall  
 #WH101  
 List \$70<sup>00</sup>

**E. Wes Hibben™ Cloak® Series Small Triple Throwing Set**  
 3 1/4" blade, 7" overall  
 #WH102  
 List \$42<sup>00</sup>





# THE EXPENDABLES 2

"THE EXPENDABLES" is a 2010 hard-hitting action/thriller movie about a group of mercenaries hired to infiltrate a South American country and overthrow its ruthless dictator. Each of these stainless steel blades is just like the ones seen in the movie, and each piece is officially licensed by United® Cutlery. Each includes a Certificate of Authenticity.

Master knife maker Gil Hibben designed this Bowie for THE EXPENDABLES movies. This cutlery masterpiece offers a stabilized synthetic ivory handle accented by the gold-plated blade catcher and guard, which are reminiscent of the styling of original bowies. THE EXPENDABLES artwork is featured on the handle, and the gold-plated guard offers cast star designs on both ends.

- A. Gil Hibben™ Bowie with Sheath**  
 14" blade, 19 3/4" overall  
 #GH5017 List \$180<sup>00</sup>

**WICKED SHARP**

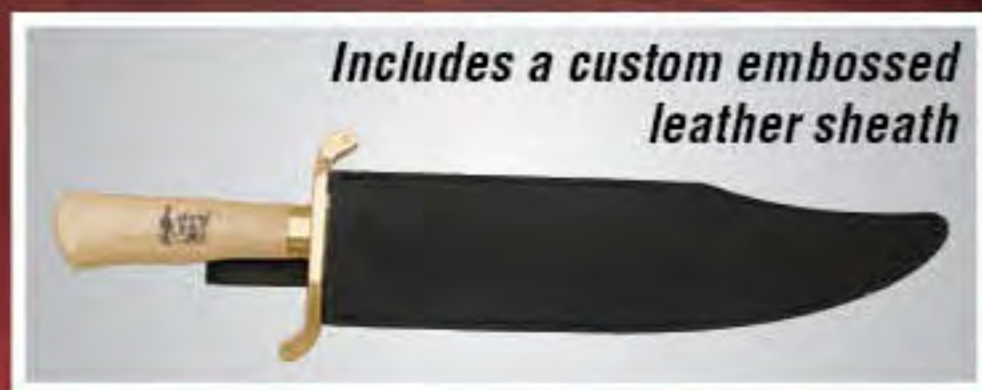

**LIGHTNING FAST**

WWW.UNITED



- B. Kunai 3-Piece Throwing Set**  
 12" overall  
 #UC2772  
 List \$57<sup>00</sup>

Includes a custom nylon sheath with leg straps for multi-carry options



HIBBEN KNIVES  
 DESIGN SERIES

Motion Picture Artwork © Lions Gate Entertainment Inc. The Expendables, The Expendables 2 © Barney's Christmas, Inc. © 2010 Alta Vista Productions, Inc. All Rights Reserved.

# THE EXPENDABLES 2

First featured in THE EXPENDABLES 2 film was this Gil Hibben custom-designed toothpick. It offers a classic, toothpick-style stainless steel blade with a solid brass back, and includes an embossed leather belt sheath and a Certificate of Authenticity.

- Mirror-polished stainless steel blade
- Hardwood handle with inlay
- Gleaming brass accents
- Embossed leather sheath

A. Gil Hibben™ THE EXPENDABLES 2 Toothpick  
11 7/8" blade, 17 1/2" overall  
#GH5038  
List \$164<sup>50</sup>

**WICKED SHARP**



Motion Picture Artwork © 2015 Lions Gate Entertainment Inc. The Expendables 2  
© 2012 Barney's Christmas, Inc. All Rights Reserved.



As seen in the hit film *THE EXPENDABLES 2*, the Hibben™ Legionnaire offers a 7Cr13 stainless steel blade with a mirror-polished finish and a handsome pakkawood handle.

- Mirror-polished 7Cr13 stainless steel construction
- Handsome black pakkawood handle
- Includes embossed leather sheath

**B. Gil Hibben™ Legionnaire Bowie**  
9 1/2" blade, 14 7/10" overall  
#GH5037  
List \$157<sup>00</sup>



Custom designed by Gil Hibben

*Gil Hibben*



Gil Hibben's Double Shadow is also shown in *THE EXPENDABLES 2*. The licensed version available through United® Cutlery features a slightly modified handle, featuring handsome black Micarta. Crafted with a unique split-blade design.

- Mirror-polished stainless steel construction
- Razor-sharp split-blade design
- Polished guard & pommel
- Premium Micarta handle
- Embossed leather sheath

**C. Gil Hibben™ Double Shadow**  
15" overall  
#GH5041  
List \$157<sup>00</sup>



HIBBEN CUSTOM  
**HIBBEN KNIVES®**  
DESIGN SERIES



**MARINES**  
THE FEW. THE PROUD.

**United® Cutlery**  
**U.S.M.C. Officially**  
**Licensed Series**

U.S. Marines need knives that they can rely on in the most intense battle and combat situations. United® Cutlery is proud to be a part of a licensing program that represents the men and women that fight for freedom on a daily basis.

**New M48® U.S.M.C. Tactical Tomahawk**

Brand new from United® Cutlery is this Officially Licensed USMC Tactical Tomahawk, built Marines strong with a powerful cast 2Cr13 steel head.

- Cast 2Cr13 stainless steel head
- 3-7/8" blade & curved spike
- Fiberglass & nylon reinforced handle
- Cord handle wrappings
- Custom blade sheath

**NEW!**

**A. M48® U.S.M.C. Tactical Tomahawk**  
8" axe head, 15 1/2" ov.  
#UC3094  
List \$74<sup>00</sup>



**MOLLE**  
ADAPTABLE  
SHEATH

HEADS ARE SECURELY  
ATTACHED TO THE HANDLES  
WITH THREE SEPARATE BOLTS.



*Made to  
breach and  
destroy*

**NEW!**

**New M48® U.S.M.C. Tactical Hammer**

The Marines need a tool they can count on, and United® Cutlery delivers in a big way with this USMC tactical war hammer.

- Cast 2Cr13 stainless steel head
- Hammer head & curved spike
- Fiberglass & nylon reinforced handle
- Cord handle wrappings
- Rubberized sheath
- Includes carabiner

**B. M48® U.S.M.C. Tactical Hammer**  
7 3/4" head, 15 1/2" ov.  
#UC3095  
List \$92<sup>00</sup>



*Includes  
flexible TPR  
belt sheath*

## New U.S.M.C. Tanto Machete

United® Cutlery is proud to release the latest blade in the popular officially licensed USMC lineup. This formidable USMC tanto machete is built Marines-strong.

- 3Cr13 stainless steel black coated sawback blade
- 3.5mm blade thickness
- OD green paracord wrapped handle
- Includes nylon snap sheath

**A. U.S.M.C. Tanto Machete**  
26" ov.  
#UC3057  
List \$46<sup>00</sup>



**NEW!**



**B**

**C**



## Marine Force Recon Sawback Bowies

U.S. Marines need knives that they can rely on in the most intense battle and combat situations. You'll never find a mission the Marine Force Recon can't accomplish, especially with the help of these massive sawback bowies. The AUS-6 stainless steel blades are corrosion resistant with a non-glare finish. The over-molded rubber handle grips feel great in your hand, and the metal hand guards will keep your fingers from slipping to the blade. Each includes a durable nylon sheath.

*B and C come with heavy duty nylon sheaths*

**B. Marine Force Recon Sawback Bowie**  
11 1/2" bl, 16 3/8" ov.  
#UC3011  
List \$38<sup>00</sup>

**C. Marine Force Recon Sawback Bowie**  
11 1/2" bl, 16 3/8" ov.  
#UC2863  
List \$38<sup>00</sup>



## Officially Licensed U.S.M.C. G-10 Collection

This collection of officially licensed USMC knives is built Marines strong. Each 420A stainless steel blade features a stonewashed finish and glides open quickly and effortlessly with the help of the assisted-open mechanism. The contoured handles are constructed of G10 with a CNC finish for a secure grip. Each one includes a stonewashed pocket clip with "USMC" wire cut right into the clip.

- 420A stonewash stainless steel blades
- Rugged G-10 handles with CNC finish
- Assisted-open technology
- Stonewashed steel pocket clip
- 7" overall in length



**A. USMC Desert Warrior**  
3 1/2" bl, 7" ov.  
#UC3086  
List \$24<sup>00</sup>

**B. USMC 2-pc. Tactical Fighting Set**  
#UC3087  
List \$49<sup>00</sup>



*B includes a 9" fixed-blade fighter knife & a 4" (closed) folder.*

**NEW!**

**NEW!**

**A**

**B**

## U.S.M.C. Combat Folder

This officially licensed U.S.M.C. Combat folding knife is one tough knife, designed specifically for marines.

- 3 1/2" black coated stainless steel blade
- Stainless steel pocket clip and window break
- Assisted-opening mechanism
- Textured aluminum handle



**MARINES**  
THE FEW. THE PROUD.

**NEW!**

**C**

**C. USMC Assisted-Open Black & Green Combat Knife**  
4 3/4" bl, 8 1/2" ov.  
#UC3098  
List \$16<sup>00</sup>



## Officially Licensed U.S.M.C. Combat Fighter

Officially licensed fixed-blade knife with razor-sharp blades crafted of 440 stainless steel with reinforced aluminum handles



**A. USMC Combat Field Fighter Knife**  
10" ov.  
#UC3018  
List \$54<sup>00</sup>

**MOLLE**  
ADAPTABLE  
SHEATH

*Includes M.O.L.L.E. nylon belt sheath*

## U.S.M.C. Combat Folders

Officially licensed USMC folders with razor-sharp blades crafted of 3Cr13 stainless steel and machined aluminum handles.



**B. USMC Combat Field Tanto Knife**  
5" cl.  
#UC3020  
List \$22<sup>00</sup>

**C. USMC Combat Field Drop Point Knife**  
5" cl.  
#UC3019  
List \$22<sup>00</sup>



USMC  
pocket  
clip



## Special Operations Association Combat Knives

Own a knife like some of the best soldiers in the world with these Special Operations Combat knives.

**NEW!**

- Stonewashed stainless steel drop point blade
- Digital Camo pattern G10 handle
- U.S.A.R.A. etch on blade
- Liner lock mechanism
- Pocket clip

**D. U.S.A.R.A. Assisted-Open Folder**  
3 1/4" bl., 4 1/2" cl.  
#UC3097  
List \$22<sup>00</sup>

**SURVIVAL APPROVED**

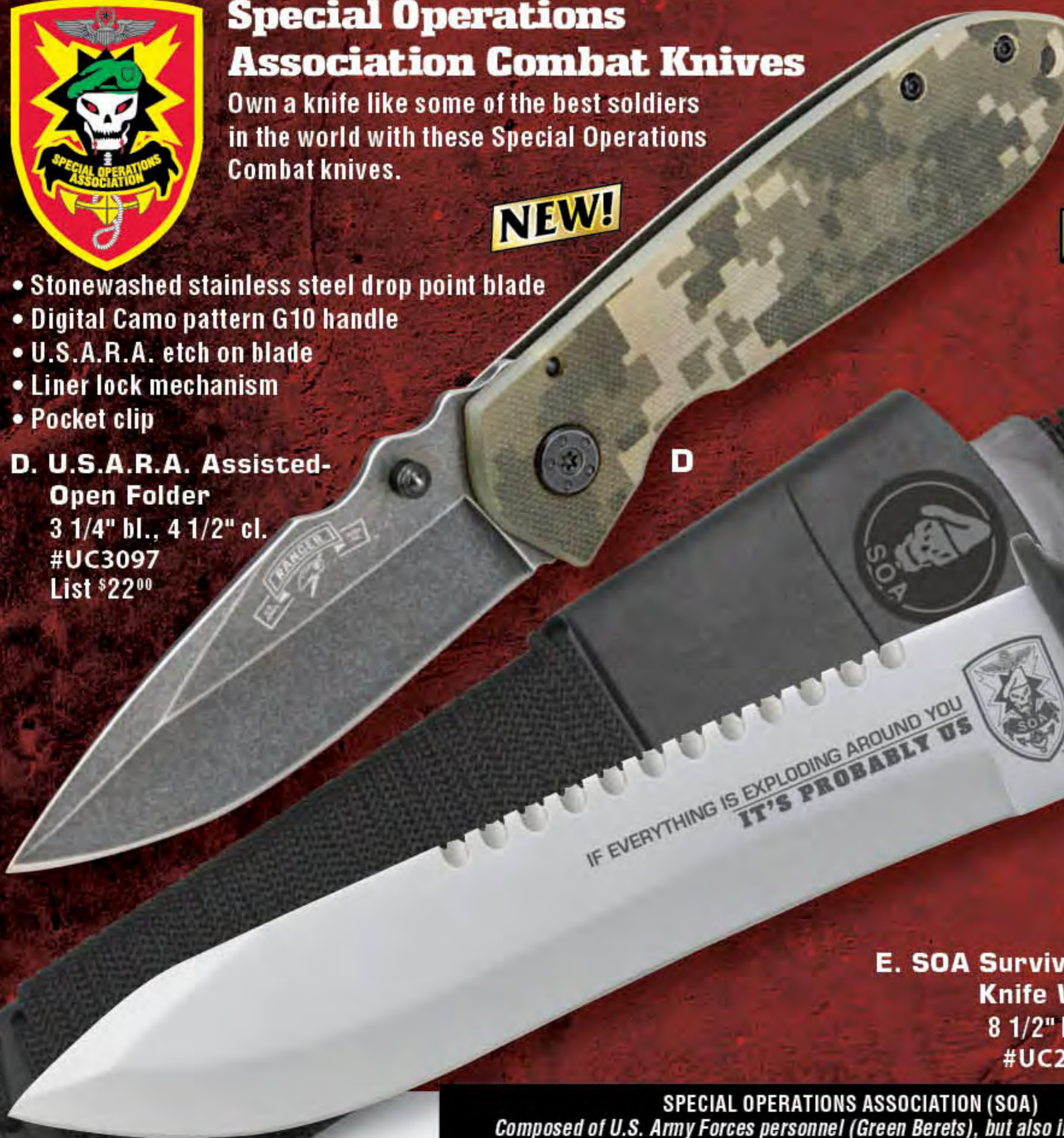

- 420 stainless steel sawback blade
- Slip-free, checkered grip handle
- Includes custom belt sheath



**E. Survival kit (included) fits inside the slip-proof, checkered-grip handle**



**The nylon sheath includes an ABS liner and rifle cartridge holder built into the side**

**E. SOA Survival Explosion Knife With Sheath**  
8 1/2" bl., 13 3/4" ov.  
#UC2699 List \$35<sup>00</sup>

**SPECIAL OPERATIONS ASSOCIATION (SOA)**

*Composed of U.S. Army Forces personnel (Green Berets), but also includes USAF Air Commandos / FACs, U.S. Navy Seals, U.S. Marine Raider and Force Recon personnel and veterans of other elite organizations who are an integral part of Special Operations.*



**M48<sup>®</sup>**